



USER MANUAL

HV-SERIES

MP 3000 HV

Welcome.

We are delighted that you have decided to purchase a **T+A** product. With your new **MP 3000 HV** you have acquired a top-quality piece of equipment which has been designed and developed with the wishes of the audiophile music lover as absolute top priority.

This system represents our very best efforts at designing practical electronic equipment incorporating solid quality, user-friendly operation and a specification and performance which leaves nothing to be desired.

All these factors contribute to a piece of equipment which will satisfy your highest demands and your most searching requirements for a period of many years. All the components we use meet the German and European safety norms and standards which are currently valid. All the materials we use are subject to painstaking quality monitoring.

At all stages of production we avoid the use of substances which are environmentally unsound or potentially hazardous to health, such as chlorine-based cleaning agents and CFCs.

We also aim to avoid the use of plastics in general, and PVC in particular, in the design of our products. Instead we rely upon metals and other non-hazardous materials; metal components are ideal for recycling, and also provide effective electrical screening.

Our robust all-metal cases exclude any possibility of external sources of interference affecting the quality of reproduction. From the opposite point of view our products' electro-magnetic radiation (electro-smog) is reduced to an absolute minimum by the outstandingly effective screening provided by the metal case.

The case of the **MP 3000 HV** is built exclusively from the finest-quality non-magnetic metals of the highest purity. This excludes the possibility of interaction with the audio signals, and guarantees uncoloured reproduction.

We would like to take this opportunity to thank you for the faith you have shown in our company by purchasing this product, and wish you many hours of enjoyment and sheer listening pleasure with your **MP 3000 HV**.

T+A elektroakustik GmbH & Co KG



The operation instructions, the connection guidance and the safety notes are for your own good - please read them carefully and observe them at all times. The operating instructions are an integral part of this device. If you ever transfer the product to a new owner please be sure to pass them on to the purchaser to guard against incorrect operation and possible hazards.



All the components we use meet the German and European safety norms and standards which are currently valid. This product complies with the EU directives 2014/35/EC, 2014/30/EC, 2009/125/EC, 2011/65/EC + 2015/863, 1999/5/EC and 2012/19/EC.

IMPORTANT! CAUTION!

This product contains a laser diode of higher class than 1. To ensure continued safety, do not remove any covers or attempt to gain access to the inside of the product.

Refer all servicing to qualified personnel.

The following caution label appears on your device:

CLASS 1
LASER PRODUCT

Contents

Operation

Front panel controls	4
Remote Control	8
Basic settings of the MP 3000 HV	11
System Settings (System Configuration menu)	11
D/A Converter Settings	13
Operating the source devices in detail	14
Operating the tuner	15
Operating the CD player	18
Playback Program	20
Operating the Streaming Client	21
Access to Media Content via the Main Menu (Home Menu)	24
Accessing Media Content using the Favourites List	25
The MP 3000 HV as D/A Converter	26
USB-DAC operation in detail	27

Using the system for the first time

Back panel connections	29
Installation and wiring	31
Safety notes	33
FCC Information to the user	34
Network Configuration	35
The vTuner Premium Service	40
Pairing the FD 100 Radio Remote Control	42

General

Glossary / Supplementary Information	43
Technical description / Digital filters / Oversampling	44
Network Terms	46
Trouble-shooting	48

Appendix

Wiring diagram	53
Specification	56

About these instructions

All the controls and functions of the **MP 3000 HV** which are frequently used are described in the first section of these operating instructions.

The second part - '**Basic settings, Installation, Using the system for the first time**' covers connections and settings which are very seldom required; they are generally required only when the machine is set up and used for the first time. Here you will also find a detailed description of the network settings required for connecting the **MP 3000 HV** to your home network.

Symbols used in these instructions



Caution!

Text passages marked with this symbol contain important information which must be observed if the machine is to operate safely and without problems.





This symbol marks text passages which provide supplementary notes and background information; they are intended to help the user understand how to get the best out of the machine.

italic

Technical terms printed in italics are explained in detail at the end of the instructions.

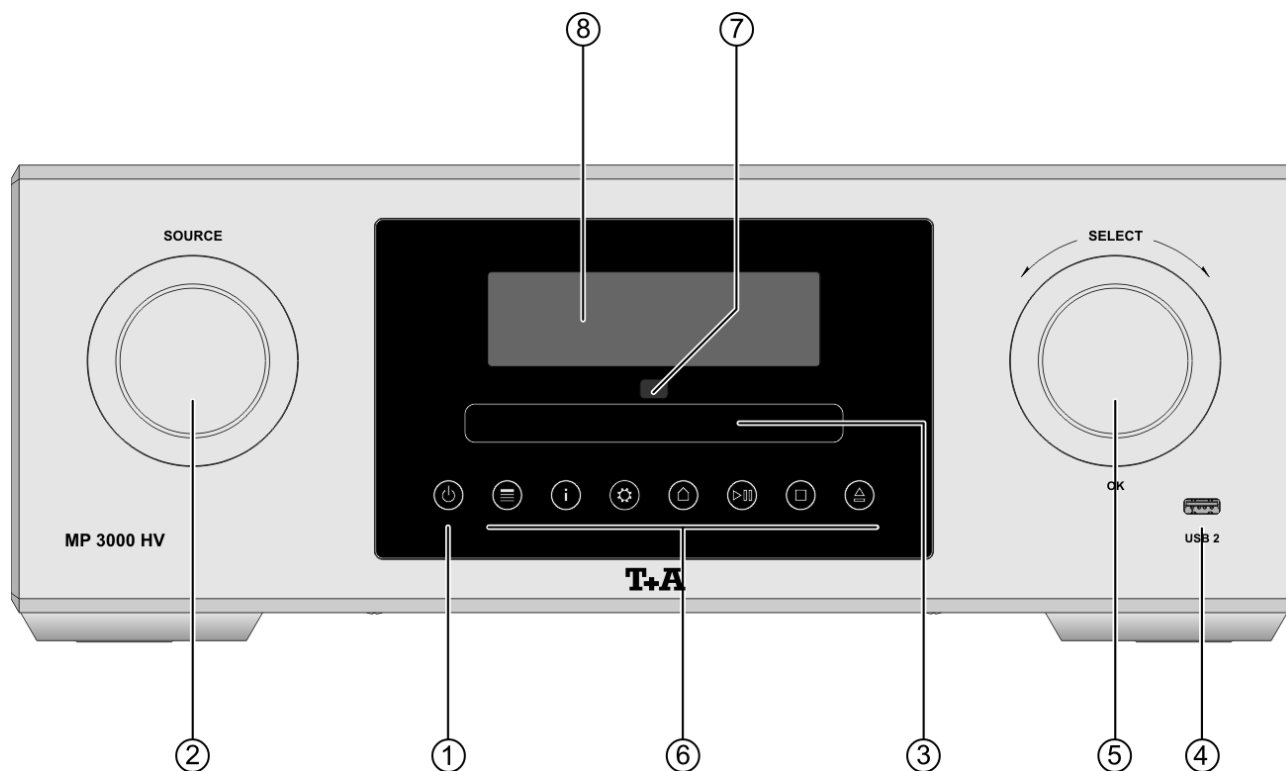
Front panel controls



All the important functions of the **MP 3000 HV** can be controlled using the buttons and rotary knobs on the front panel. The large rotary knobs are used for navigation in lists and menus and to select the listening source. Functions which are needed less frequently are controlled using a menu which is called up by pressing the  button.

All information relating to the machine's state, the current track and the associated transmitting station are displayed on the integral screen. The following section explains the functions of the buttons on the machine, and the information provided on the screen.

① On / Off switch



Touching the  button briefly switches the device on and off.



The  button remains dimly lit even in stand-by mode, to indicate that the **MP 3000 HV** is ready for use.



Caution!

The mains button is not an isolation switch. Certain parts of the machine remain connected to mains voltage even when the screen is switched off and dark. If you know you will not be using the machine for a long period, we recommend that you disconnect it from the mains by withdrawing the mains plugs from the wall socket.

② Source selection

SOURCE

The desired listening source is selected by turning this rotary knob; your chosen source then appears on the screen. After a short delay the machine switches to the appropriate source.

③ CD drawer

The CD drawer is located below the display. Please insert the disc with the label side facing upwards into the appropriate depression of the tray.

The drawer is opened and closed by touching the  button.

④ Front USB socket (USB 2)

Socket for a USB memory stick or an external hard disc.

The storage medium must be formatted with the FAT16 or FAT32 file system.

The USB storage medium can be powered via the USB socket provided that its current drain meets the USB norm (< 500 mA). Normalised 2.5" USB hard discs can be connected directly to this socket, i.e. they require no mains PSU.

⑤ Navigation / Control

SELECT

Rotating this control selects a track for playback; the selected track then appears on the screen. As soon as the desired track number lights up, the track can be started by pressing the incremental control.

 In addition to selecting tracks, the incremental control also has other purposes such as menu and list control functions (for further details see the chapter entitled '**System settings**') and creating playback programs.

⑥ Operating buttons



Calls up the Favourites list



Brief touch: Toggle switch between display of current music track and list navigation / switches the CD Text on and off.

Long touch: Switches between different screen displays



Opens the '**System Configuration**' menu
(for further details see the chapter entitled '**System settings**')



When SCL (Streaming Client) is selected as source:

A brief touch switches to main menu (Home)

Long touch:

Switching between the USB inputs **USB 1** (Back panel) and **USB 2** (Front).

It is only possible to switch inputs in the top menu level of the SCL (main menu).



Starts playback

Halts current playback (pause)

Resumes playback after a pause



Ends playback



The drawer is opened and closed by touching the  button.

⑧ Display

The graphic screen of the **MP 3000 HV** displays all information regarding the status of the machine, the music track currently being played and the radio station currently tuned. The display is context-sensitive and varies according to the capabilities and facilities of the service or medium to which you are currently listening.

The most important information is highlighted on the screen in a context-sensitive manner. Supplementary information is displayed above and below the main text, or by means of symbols. The symbols used are listed and explained in the table below.

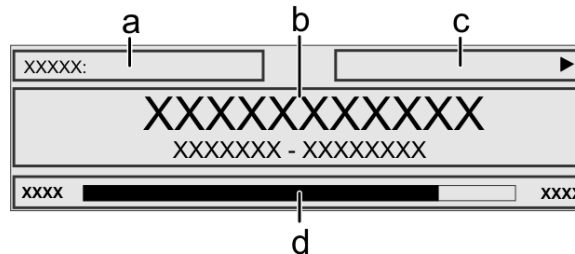

e.g.





The displays and symbols which appear on the screen vary according to the currently active function (SCL, Disc, etc.) and the type of music currently being played.

The basic areas of the screen:

















- Display field (a) shows the currently active source.
- Display field (b) shows information relating to the piece of music being played. The essential information is displayed enlarged in the main line.
- Display field (c) shows information relating to the device and playback.
- The bottom line (d) displays supplementary context-sensitive information (e.g. bitrate, elapsed time, state of reception)



The **MP 3000 HV** provides different screen displays for the Streaming Client, the CD player and the radio.

- **Large-format display:**
Enlarged display of the most important information, clearly legible even from a distance
- **Detail display:**
Small-text display showing a large number of additional information points, e.g. bit-rate etc.
A long press on the  button on the remote control handset or the  button on the front panel is used to switch between the display modes.

Screen symbols and their meaning

	Making connection (Wait / Busy) The rotating symbol indicates that the MP 3000 HV is currently processing a command, or is attempting to connect to a service. These processes may take some time to complete depending on the speed of your network and the load upon it. During such periods the MP 3000 HV may be muted, and may not respond to the controls. Please wait until the symbol disappears, then try again.
	Indicates a music track which can be played , or a playlist .
	Indicates a folder which conceals further folders or lists.
	Indicates that a source is being reproduced via a cable connection .
	Indicates that a source is being reproduced via a radio connection .
	Indicates that the MP 3000 HV is reproducing a station or playing back a music track.
	Pause indicator
	Indicates the selected USB socket.
	Indicates that the speakers A and B are switched off. (in 2-zone mode only if speakers A are switched off)
	Buffer display (fullness indicator, memory display) and data rate indicator (if available): The higher the data rate, the better the quality of reproduction.
	Display of the elapsed playback time. This information is not available for all services.
	Indicates that the  button can be used to switch to a higher menu or select level.
0 / 0	Position indicator in select lists. The first number shows the current position in the list, the second number the total number of list entries (length of list).
	Indicates that the selected menu item or list point can be activated by pressing the  button.
ABC 123 abc	Display of the symbol input modes
	Indicates the field strength of the radio signal.

Remote control

General

All the **MP 3000 HV** mechanism control functions and auxiliary functions can be operated using the remote control system.

In general terms the remote control buttons have the same function as the corresponding buttons on the **MP 3000 HV** front panel.

Because the FD100 remote control works with radio frequency signals it is necessary to connect a RF antenna to the "FD100 Remote ANT" socket on the back panel of the **MP 3000 HV** (see the connection diagram in appendix A). If the remote control is used for the first time, it is necessary to carry out the pairing procedure between the **FD100** and the **MP 3000 HV** (see chapter 'Pairing the FD100 radio remote control')







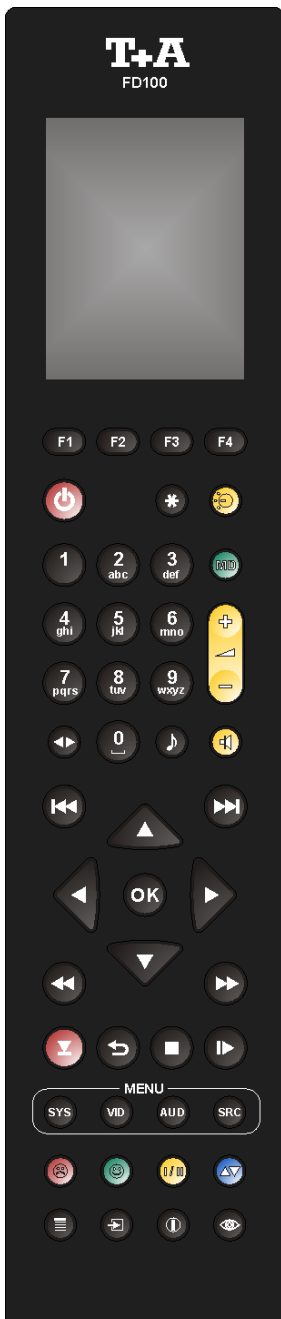





The following tables show the remote control buttons and their function when operating the machine.















The **FD100** remote control is no multi room remote control. Its maximum operating distance under normal conditions is about 12 meters. Obstacles like walls or furniture can decrease the operating distance. The operating distance can be increased by moving the receiving antenna to a location where it has free line of sight to the FD 100 handset.



	Switches the MP 3000 HV on and off
	Source select button
	Direct alpha-numeric input, e.g. track number, quick station select, radio station Special characters are also assigned to the and buttons. During the text input process it is possible to switch between numerical and alpha-numeric input, and between capital and lower-case letters, using the button.
	Switches the loudspeaker outputs of an amplifier connected via H-Link bus ON and OFF. (MUTING). (e.g. PA 3000 HV)
	Decrease / increase the volume of an amplifier connected via H-Link bus
	Opens the Tone- / Balance- Control menu of an amplifier connected via H-Link bus.
	Opens the System Configuration menu of an amplifier connected via H-Link bus.
	A long press is used to switch between two different front panel display modes.

	Tuner	CD-Player	Streaming Client
	Navigation		Navigation
	Back to previous point During alpha-numeric character input you can erase a character with the  button.		Back to previous point
	Confirms input		- Opens a folder - Starts a piece of music - Selects an Internet radio station
	Selects the previous point within a list		Selects the previous point within a list
	Selects the next point within a list		Selects the next point within a list
	Confirm buttons during input process		
	Chapter select / Track select / Search / Manual tuning		
		Selects the previous track during playback	Selects the previous piece in the playback list
	Brief press: Manual tuning Long press: Search	Rewind to search for a particular passage	Hold button pressed in for rewind
	Brief press: Manual tuning Long press: Search	Fast-forward to search for a particular passage	Hold button pressed in for fast forward
		Selects the next track during playback	Selects the next piece in the playback list
 (REPEAT)		Repeat function (see Chapter ' <i>Operating the CD player</i> ')	Repeat functions (not possible with all media) Brief press: Repeat Track, Repeat ALL, 'Normal' Long press: Mix-Mode (Shuffle) ON / OFF Brief button presses in MIX mode: Mix, Repeat Track, Repeat Mix
 (STOP)		Brief press: Halts playback Long press: Opens and closes the CD draw in STOP mode	Ends playback
 (PLAY/ PAUSE)	Select station from Favourites list	<ul style="list-style-type: none"> • Starts playback (Play function) • During playback: halts (Pause) or resumes playback 	<ul style="list-style-type: none"> • Starts playback (Play function) • During playback: halts (Pause) or resumes playback

	Tuner	CD-Player	Streaming Client
	Opens the System Configuration menu (e.g. for adjusting screen brightness)		
	Opens the Favourites menu when the Favourites list is displayed.		Brief press: Switches to main menu (Home) Long press: Opens the network configuration menu
	Long press: Removes a favourite from the station list	Long press: Erases <i>playback program</i>	Long press: Removes a favourite from the Favourites list created on the MP 3000 HV
	Adds a favourite to the station list	Activates playback programming Adds a <i>track</i> to the <i>playback program</i> during playback programming	Adds a favourite to the Favourites list created on the MP 3000 HV
	Button for switching between Stereo and Mono reception The Stereo setting is constantly displayed in the screen window by a  symbol. The Mono setting is constantly displayed in the screen window by a  symbol.		the main menu is displayed: Toggle switch between inputs USB 1 and USB 2
			During character input: Switches between numeric and alpha-numeric input, and between capitals and lower case when pressed (repeatedly) In lists: Search function (Alpha search)
	Displays the Favourites list		Displays the Favourites list created on the MP 3000 HV
	Store button for fast station select		Store button for fast station select
	Switches the Radiotext function ON/OFF	Switches CD-Text ON/OFF	Toggles the display between the 'Now Playing' view and track list / station list navigation.
	Switches between the <i>Digital filter</i> / Invert functions		



The **MP 3000 HV** can be controlled by the **T+A** App 'TA Control' too.

For further information please visit our homepage

www.ta-hifi.com/app

Smartphone



Tablet PC





Basic settings of the MP 3000 HV

System Settings (System Configuration menu)



In the System Configuration menu general device settings are adjusted. This menu is described in detail in the following chapter.

Calling up and operating the menu

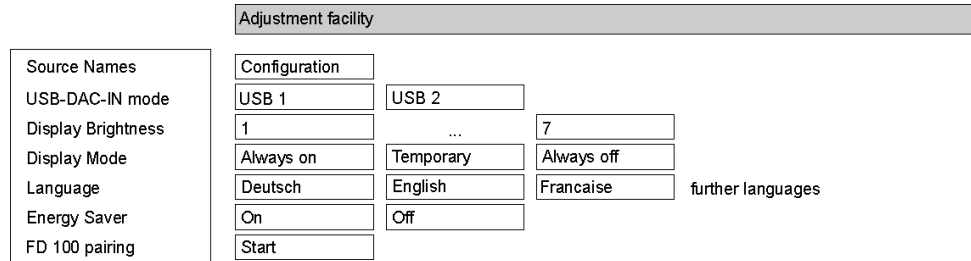







- Briefly press the  button on the front panel or  button on the remote control handset to call up the menu.
- When you open the menu, the following Select points appear on the screen:



Using the front-panel controls:

- The SELECT knob is used to select any item within the menu system.
- To change a selected menu item, press the SELECT knob to confirm your choice, then adjust the value by rotating the knob.
- After making the adjustment, press the SELECT knob again to adopt the new setting.
- You can interrupt the process at any time by touching the  button; in this case any changes you have made are discarded.
- Holding the SELECT knob pressed in takes you one level further down in the menu system.
- Touch the  button again to quit the menu.



Using the remote control handset:



- Use the  /  buttons to select an item in the menu.
- If you wish to change a selected menu item, first press the  button, and then use the  /  buttons to alter it.
- **After making the change, press the  button again to accept the new setting.**
- You can press the  button at any time to interrupt the process; the change is then abandoned.
- Press the  button again to leave the menu.

Source names menu item

At this menu item you can activate and disable external sources, and assign a plain text name to each source; this name then appears in the screen displays. When you call up this menu item using the  button, a list of all the external sources of the **MP 3000 HV** appears. Each source is followed by the assigned name, or if you have disabled the source concerned the note 'disabled'.

If you want to activate / disable a source, or change the plain text name, navigate to the appropriate line.

To activate a source, press the green  button; pressing the red  button disables the source.

To change the plain-text name, move to the appropriate line and press the  button. Now use the alpha-numeric keypad of the **FD100** to change the name as required, then confirm your choice with ; this saves the settings for that source.

The  button is used to switch between numeric and alpha-numeric input, and between capitals and lower-case letters.

Letters can be erased by pressing the  button.

If you should wish to restore the factory default source name, erase the whole name before saving the empty field with the **OK** button: this action resets the display to the standard source names.

i When you call up Source Select using **Source Select** button on the remote control handset or the source select knob on the front panel, any disabled sources are suppressed. This makes it easier to select sources, and we recommend that you disable any sources not in use.

The only available method of entering the name is to use the alphanumeric keypad on the remote control handset.

USB-DAC-IN mode menu item

The **MP 3000 HV** can be connected to any computer with a USB 1.0 or USB 2.0 interface. Here you can select the USB operation mode (USB 1.0 or 2.0) according to the requirements of your source device. The **MP 3000 HV** is set up for connection to a USB 1.0 port by default. If you wish to operate the machine with a USB 2.0 port in USB Audio Class 2 mode (High-Speed mode, maximum sampling frequency 192 kHz), you have to switch the USB mode to USB2.

i To play audio files in USB Audio Class 2 mode, you must first install the appropriate driver for your operating system. (see chapter "The **MP 3000 HV** as D/A Converter")

Display Brightness menu item

At this point you can adjust the brightness of the integral screen to suit your personal preference for normal use.

i We recommend that brightness settings 6 and 7 should only be used when the screen is difficult to read due to very bright ambient light. A lower brightness setting will extend the useful life of the screen.

Display Mode menu item

This menu item offers the choice between three different display operation modes:

- Always on
- Temporary
- Always off

Selecting '**Temporary**' will switch the display is on for a short while each time the **PA 3000 HV** is being operated. Shortly after operation the display will be switched off again automatically.

i The brightness of the display can be adjusted separately with the menu item '**Display Brightness**' (see above).

Language menu item

In this menu item you define the language to be used for the displays on the screen of the front panel of the **MP 3000 HV**.

The language used for data transferred to the machine, e.g. from an iPod or other Internet radio station, is determined by the supplying device or the radio station; you cannot define the language on the **MP 3000 HV**.

Energy Saver menu item

The **MP 3000 HV** features two stand-by modes: ECO Standby with reduced stand-by current drain, and Comfort Standby with additional functions, but slightly higher current drain. You can select your preferred stand-by mode in this menu point:

On (ECO Standby):

Active functions in ECO Standby mode: can be switched on only at the device itself.

Off (Comfort-Standby):

The following expanded functions are available: Can be switched on by remote control **FD100**.

Pair FD 100 menu item





When you call up this menu item, the **MP 3000 HV** attempts to create a connection with the FD 100 radio remote control (see chapter '**Pairing the FD100 radio remote control**').

D/A Converter Settings

A number of special settings are available for the **MP 3000 HV** D/A converter; they are designed to fine-tune the characteristics of your amplifier to suit your listening preferences.

Calling up and operating the D/A converter options

Briefly press the  button on the remote control handset in order to call up the D/A converter set-up options. This action opens a set-up window in which the various options are displayed.

- Now use the  /  buttons to select a set-up option.
- In each case the displayed option can be altered using the  /  buttons.
- Press the  button again to leave the menu.

DSP set-up option Oversampling (OVS)

The **MP 3000 HV** can exploit four different filter types offering different tonal characters:

- Oversampling **FIR long** is a classic FIR filter with an extremely linear frequency response.
- Oversampling **FIR short** is a FIR filter with improved peak handling.
- Oversampling **Bezier / FIR** is a Bezier interpolator combined with a IIR filter. This process produces a result very similar to an analogue system.
- Oversampling **Bezier** is a pure Bezier interpolator – offering perfect “timing” and dynamics.

 Please refer to the Chapter '**Technical description - Digital filters / Oversampling**' for an explanation of the different filter types.

DSP set-up option Output phase

With particular instruments or voices the human ear is certainly capable of detecting whether absolute phase is correct or not. However, absolute phase is not always correctly recorded.

In this menu item the phase of the signal can be changed from normal to inverse phase and back.

 The correction is carried out at the digital level, and has absolutely no adverse effect on sound quality.

DSP set-up option Bandwidth (BW)

In this menu item, the bandwidth of the analogue output filter can be switched between 60 kHz (normal mode) or 120 kHz ('WIDE' mode).

The 'WIDE' setting allows a more spacious music reproduction.

 Please refer to the Chapter '**Technical description - Digital filters / Oversampling**' for an explanation of the different filter types.

Operating the source devices in detail

Operation of the MP 3000HV with the FD100 remote control



Operation of the MP 3000 HV with controls on the front panel of the device

The operation of the source devices is described in the following chapters using the **FD100** remote control because only with this remote control all functions of this device can be operated (e.g. adding favourites).

The front panel controls can be used to operate the basic functions of the **MP 3000 HV**.

The SELECT knob can be used to navigate through lists and menus or to control the CD player in the same way as the cursor and OK buttons of the **FD100** remote.

In Lists

- Choose a list or menu item by turning the SELECT knob.
- By pressing the SELECT knob you can select an item or start playback of a title or station.
- By pressing the SELECT knob for a longer time you can leave a submenu or navigate to the parent menu level (BACK).
- Briefly touching the  sensor button directly opens the main menu.
- When in the main menu touching the -button for a longer time toggles between the USB inputs (front/back USB inputs)

CD Mechanism Control

- Turning the SELECT knob lets you select a track on the CD.
- When the desired track number lights up on the display this track can be started by pressing the SELECT knob.

Operating the Tuner

Selecting the FM tuner as source

First choose the built in FM tuner as listening source by opening the source selection menu on the **FD100** remote by pressing the -button or by turning the rotary source selector (SOURCE) on the front panel of the **MP 3000 HV**.

When you select a station, the integral screen initially shows the reception frequency or the *RDS* station name.

Front panel display



The **MP 3000 HV** provides different screen displays for the the radio.

- **Large-format display:**
Enlarged display of the most important information, clearly legible even from a distance
- **Detail display:**
Small-text display showing a large number of additional information points, e.g. frequency etc.

A long press on the -button on the remote control handset is used to switch between the display modes.



Fig.
Large-format display

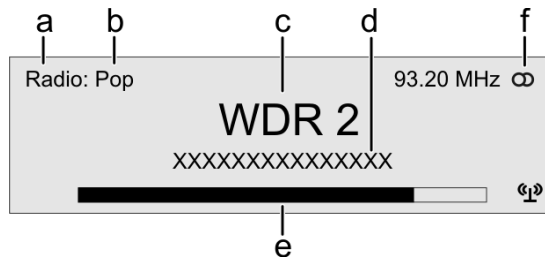





Fig.
Detail display

The screen on the front panel displays all information in a clear form.

Field strength display

- When you are listening to a radio station in Tuner mode, the message **'Radio'** appears in the top line of the screen.
- Here the music type or style is displayed, e.g. Pop Music.
This information is only displayed if the transmitting station broadcasts it as part of the *RDS* system. If you are listening to a station which does not support the *RDS* system, or only supports it in part, these information fields remain empty.
- The frequency and / or the station name is displayed in enlarged form. If a station name is displayed, its frequency is shown in the right upper corner.
- These lines display information which is broadcast by the station (e.g. Radiotext).
- The *field strength*  and therefore the reception quality to be expected from the set transmitting station can be assessed from the field strength.
- Display of Stereo '' / Mono ''

Selecting a station using the Favourites list:

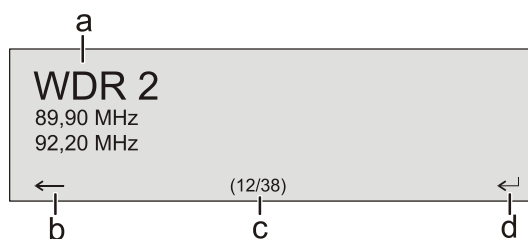

- a) The selected station is displayed in enlarged form, and can be called up using the / / button.
- b) Press the button to return to the station previously selected.
- c) Position display in the Favourites list.
- d) Press the / / button to select the station displayed in enlarged form.

Holding one of the / buttons pressed in initiates a station search in the upward or downward direction. The station search stops automatically at the next station.

Station Search

Favourites List and Presets





In addition to manual tuning and searching, the tuner of the **MP 3000 HV** also features a **Favourites list** and **Presets**, which provide a fast, convenient method of managing your preferred stations and calling them up at any time.

You can edit the Favourites list to suit your preferences (see section '**Adding stations to the Favourites list / Erasing stations from the Favourites list**').

It is also possible to store the stations under a station number (Preset), and then to call it up directly by entering the station number. Presets are particularly useful if you wish to call up stations when the screen is not in sight (e.g. from an adjacent room), or via the domestic control system.

The Favourites List

Creating the Favourites list

When you have called up the Favourites list by pressing the  button, you can press the  button to call up the Favourites menu, from which the following points can be selected using the  /  buttons:



Manage Favourites	
Sort Favourites by	Frequency
Scan for stations	Start

Select the menu item '**Scan for stations**' and initiate the station search with the  button. The screen displays the message '**Auto Store active**', and the **MP 3000 HV** now automatically stores up to sixty receivable stations in the Favourites list.







Sort function



The Favourites list can be sorted according to various criteria; these are selected in the menu item '**Sort Favourites by**':

Frequency / Station name / Program ID





Now use the  /  buttons to select the desired sort criterion, and confirm your choice by pressing the  button.

Selecting radio stations from the Favourites list

- Call up the Favourites list with the  button, select a stored station from the Favourites list using the  /  buttons, and confirm your choice with the  /  /  button.

- You can also select stations directly, without calling up the Favourites list as described above, by briefly pressing the  /  buttons.

Adding stations to the Favourites list



First set the desired station manually (by briefly pressing the  /  buttons) or using a search (holding the  /  buttons pressed in). As soon as the station is audible, you can add it to your Favourites list by pressing the  button.

Erasing stations from the Favourites list



Open the Favourites list. Select the station you wish to erase from the list, hold the red  button pressed in for a few seconds: the station is now removed from the Favourites list. After the erasure the tuner automatically switches to the next station in the Favourites list.

Presets



Calling up a Preset

At any time you can quickly call up a station stored as a Preset by entering its Preset number using the **F100 / FM100's** numeric buttons  to .

Storing a Preset

- Select a station, either using the  /  buttons, or from the Favourites list.

- Call up the Store Preset function by pressing the  button.

- An input window now appears in which you can enter a number using the numeric buttons ( to ). The Preset is stored when you press a numeric button. The front panel screen briefly displays the message '**Preset Stored at**' to confirm this.

RDS functions

If the station being received is broadcasting relevant RDS data, the following information will be displayed on the screen:

- Station name
- Radiotext
- Program type (genre)

Mono / Stereo

You can toggle the tuner of the **MP 3000 HV** between stereo and mono reception by briefly pressing the  button. The reception mode is shown on the screen by the following symbols:

'●' (Mono) or '◐' (Stereo):

If the station you wish to listen to is very weak or very distant, and can only be picked up with severe background noise, you should always switch to MONO mode as this reduces the unwanted hiss significantly.





When you store the station in the Favourites list, the settings you enter for this station are also stored, and are automatically restored the next time you call up the station.

Operating the CD player



Selecting the CD player as source

First choose the built in CD player as listening source by opening the source selection menu on the **FD100** remote by pressing the -button or by turning the rotary source selector on the front panel of the **MP 3000 HV**.

Inserting a CD

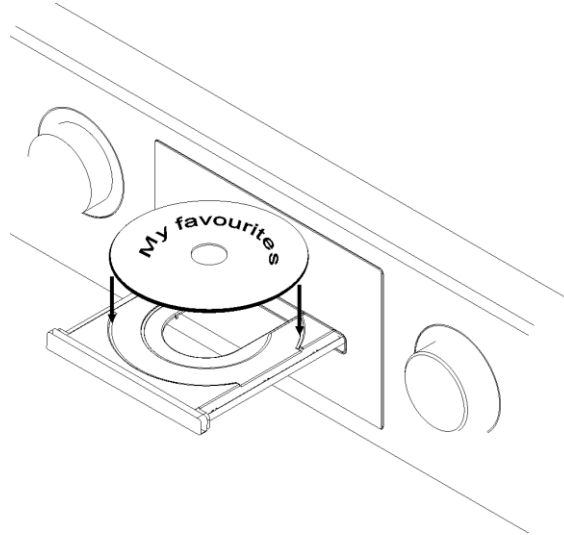
- Open the CD drawer ( on the front panel /  FD100 / FM100)
- Place the disc **centrally** in the appropriate depression in the drawer, **with the side to be played facing down**.



- Close the CD drawer ( on the front panel /  FD100 / FM100)

When you close the drawer, the machine immediately reads the CD's 'Table of Contents'; the screen displays the message **'Reading'**. During this period all button-presses are ignored.

The screen then displays the total number of tracks on the CD in the drawer, e.g.: **'13 Tracks 60:27'**.

It also shows the current mode of operation, e.g. 

Front panel display



The **MP 3000 HV** provides different screen displays for the CD player.

- **Large-format display:**
Enlarged display of the most important information, clearly legible even from a distance
- **Detail display:**
Small-text display showing a large number of additional information points, e.g. bit-rate etc.

A long press on the -button on the remote control handset is used to switch between the display modes.



Fig.
Large format display

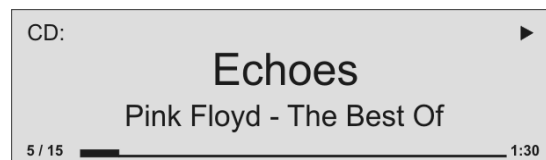



Fig.
Detail display



Playing a CD

Press the  button on the front panel or on the F100 / FM100 remote control handset to begin the playback process.



Playback starts, and the screen shows the mode of operation () and the number of the track currently being played: **'Track 1'**.

The CD stops after the final track, and the screen again displays the total number of CD tracks and the overall running time.

Variations

If you press the  /  button after placing the CD in the machine, the drawer closes and playback starts with the first track.

The open drawer also closes if you enter the number of a track using the remote control handset.

You can interrupt playback at any time by pressing the  button. During the interruption the screen displays the  symbol.

Press the  button again to resume playback.



Briefly pressing the  button during playback causes the player to skip to the start of the next track.

Briefly pressing the  button during playback causes the machine to skip back to the start of the preceding track.

A brief press on the  button concludes playback.

A long press on the  button opens the CD drawer.

Track Select During playback

Briefly press the  or  button repeatedly until the number of the track you want to hear appears on the integral screen.

Releasing the button interrupts playback briefly, and after this the desired track is played.

 You can also enter the number of the desired track directly using the numeric buttons on the remote control handset.

The CD player in the **MP 3000 HV** features various playback modes. During playback the current playback mode is shown on the screen.

Playback mode



Repeat

Brief press:

Repeatedly pressing the  button causes the machine to cycle through different playback modes.

'Repeat All' / 'Repeat Program'	The tracks of the CD or a <i>playback program</i> are continuously repeated in the preset sequence .
'Repeat Track'	The track of the CD or a <i>playback program</i> which has just been played is continuously repeated.
'Normal' / 'Program'	Normal playback of the whole disc, or normal program playback.

Mix mode

Long press:

Holding the  button pressed in switches the machine to Mix mode. A second long press ends Mix mode.

'Mix' / 'Mix Program'	The tracks of the CD or of a <i>playback program</i> are played in a random sequence .
--------------------------	---

In Mix mode the Repeat function can be called up with a brief press of the  button.

'Repeat Mix' / 'Rpt Mix Program'	The tracks of the CD or of a <i>playback program</i> are continuously repeated in a random sequence .
-------------------------------------	--

Fast Search

- Fast forward search (hold the  button pressed in)
- Fast reverse search (hold the  button pressed in)

Holding the button pressed in for a long period increases the rate (speed) of search. During the search process the screen displays the current track running time.

Playback Program

Creating a *Playback Program*

Explanation:

A playback program consists of up to thirty tracks of a CD stored in any order you like. This can be useful, for example, when you are preparing a cassette recording. A playback program can only be created for the CD currently in the disc drawer of the **MP 3000 HV**. The program remains stored until it is erased again, or until the CD drawer is opened. The program can only be created while playback is stopped.



Operation:

When you place the CD in the drawer, the screen displays the total number of tracks on the disc, e.g.: **'13 Tracks 60:27'**.

- Activating playback programming mode.



Press the  button

The screen displays the message **'Add Track 1 to Program'** and **'0 Tracks / 0:00 Program time'**.

- Repeatedly press the  or  button briefly until the number of the desired track appears on the screen after **'Track'**.
- Now store the track in the playback program by briefly pressing the  button.

The screen shows the number of *tracks* and the total playing time of the playback program. Select all the remaining tracks of the program in the same manner, and store them by briefly pressing the  button.



It is also possible to enter the track directly using the numeric buttons, instead of using the  /  buttons. After you enter the number, press the  button briefly to store the track, as described above.

If you store thirty tracks, the screen displays the message **'Program full'**.

The playback programming process is concluded when all the desired tracks have been stored.

- End the playback programming process.



Hold the  button pressed in for about one second

Playing a playback program

The playback program can now be played.

- Start the playback process.  button

Playback starts with the first track of the playback program. The screen displays the message **'Program'** while a playback program is playing.

The  and  buttons select the previous or next track, but only within the playback program.

Erasing a playback program

Briefly pressing  button in **STOP** mode opens the CD drawer, and thereby erases the playback program.

A playback program can also be erased without opening the CD drawer:

- Erase the playback program.

Hold the  button pressed in again for about one second

The playback program is now erased.

Operating the Streaming Client

General Information on the Streaming Client

The **T+A MP 3000 HV** includes what is known as a 'Streaming Client'. This is a new class of playback devices for media content, providing a means of playing music which is stored on a vast variety of sources. These sources may be an USB hard disc connected directly to the **MP 3000 HV**, but they may also be thousands of miles away (e.g. Internet radio station). The Streaming Client can access such remote sources via a home network and the Internet.

 The network configuration is explained in the Chapter '**Network Configuration**'.

The **MP 3000 HV** Streaming Client can access the following sources:

Local sources (direct connection)	Remote sources (via home network or Internet)
USB memory sticks and USB hard discs	Internet radio
	NAS server (with UPnP-AV server)
	PC (with UPnP-AV server)

The media content formats which the **MP 3000 HV** can reproduce are very wide-ranging, and extend from compressed formats such as MP3, WMA, AAC and OGG Vorbis to high-quality non-compressed data formats such as FLAC and WAV, which are thoroughly audiophile in nature. A full listing of all possible data and playlist formats is included in the Specification, which you will find in the Appendix to these instructions.

Since virtually no read or data errors occur when electronic memory media are accessed, the potential reproduction quality is even higher than that of CD. The quality level may even exceed that of SACD and DVD-Audio.

The **MP 3000 HV** can also play back high-resolution audio formats (FLAC and WAV up to 192kHz / 32bit). High-resolution audio files can be played back from a USB hard disc connected to the unit, or via a network connection. However, if you wish to use a network for 192/32 reproduction, a cable network must be used since a WLAN network is not generally sufficient for the high data rates (see also the note in the chapter entitled '**Network configuration**').













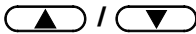

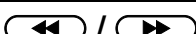

Select Lists

The music content to be played is chosen from Select Lists. These lists are operated using the navigation buttons (cursor buttons) which you will find on the remote control handset and on the front panel. All content can be accessed via the main menu. Internet Radio in particular offers a huge number of stations, which can result in long searches or periods of navigation. We therefore recommend that you store your preferred stations in a **Favourites List**, as this makes them easy and fast to access, with no protracted searching. It is also possible to store Internet radio stations as **Presets**, just as you do with normal radio; they can then be called up directly just by entering a number.

The media content can be listed according to various criteria - Internet radio stations e.g. by country of origin, genre or alphabetical, music from media servers e.g. by artiste, album, track, genre, etc.

 The exact form of the displayed list and the preparation of the content also depend to a large extent on the capabilities of the server, i.e. the full facilities of the **MP 3000 HV** cannot be exploited with all servers or media. You may therefore find that in many cases not all the functions described in these instructions can be used.

The following table shows the buttons on the remote control handset and their basic function when operating the Streaming Client:

	Selects the Streaming Client as listening source.
	Brief press: Switches to the main list (Home function) Long press: Opens the Configuration menu
	Selects the menu item within a list
	Opens a folder , starts a piece of music or playlist
	Back to the next higher menu level
	Plays the selected track or folder During input operations: confirms the input
	Selects the previous or next piece in the playback list. Hold button pressed in for fast forward and rewind search.
	Hold button pressed in for fast forward and rewind search.
	Ends playback (STOP)
	<ul style="list-style-type: none"> Starts playback (PLAY function) Halts playback (PAUSE) or mute and resume, if available
	Long press: Removes a favourite from the Favourites list created on the MP 3000 HV
	Adds a favourite to the Favourites list created on the MP 3000 HV . If no memory space is available, the screen displays the message 'Favorite List Full'.
	Displays the Favourites list created on the MP 3000 HV .
	<i>Preset store button</i>
 (not possible with all media)	<p>Repeated brief presses cycle through the repeat functions:</p> <p>→ Rpt Trk, →Rpt All, →Normal</p> <p>Rpt Trk The current piece is repeated</p> <p>Rpt All All pieces in the current folder / the current playlist are repeated</p> <p>Normal Repeat function switched off</p> <p>Long press: Switches Mix mode (Shuffle) ON and OFF Subsequent brief button presses will cycle through the Mix Repeat operating modes:</p> <p>→ Mix, → Rpt Trk, → Rpt Mix</p> <p>In Mix mode the pieces are played in a random order.</p>
	<p>During character input operations:</p> <p>Toggle switch: when pressed repeatedly this button toggles between numeric and alpha-numeric input, and between capitals and lower case</p> <p>While navigating through lists:</p> <p>Calls up the Search function (Alpha search)</p>
	A long press is used to switch between two different front panel display modes.

Screen

All information relating to machine status, the current music track and navigation in lists is displayed on the **MP 3000 HV** graphic screen. The display is context-sensitive, and varies in part according to the capabilities and facilities of the service to which you are currently listening.

The essential information is displayed in enlarged form in the main line of the screen. Supplementary information is shown above and below it in smaller lettering, or by symbols. The table below shows and explains the symbols employed.

- ① The **MP 3000 HV** provides different screen displays for the Streaming Client.
- **Large-format display:**
Enlarged display of the most important information, clearly legible even from a distance
 - **Detail display:**
Small-text display showing a large number of additional information points, e.g. radio text etc.
- A long press on the -button on the remote control handset is used to switch between the display modes.



Fig.
Large format display

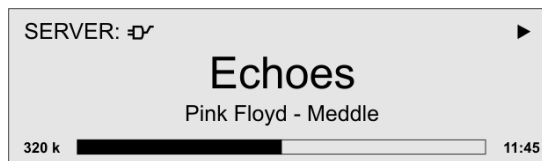

Fig.
Detail display

The screen can display the following symbols:



Making connection (Wait / Busy)

The rotating symbol indicates that the **MP 3000 HV** is processing a command, or is making the connection to a service. These processes may take a little while, depending on the speed and current load of the network. During this period the **MP 3000 HV** may be muted, and may not respond to commands. If this should happen, please wait until the symbol disappears.



Indicates a **playable music track** or a playback list (Playlist)



Indicates a **folder**, concealing further folders or lists.



Indicates that the listen source is connected by cable LAN.



Indicates that the listen source is connected by wireless WLAN.



Indicates that the **MP 3000 HV** is playing a station or a music track



Pause indicator



Buffer display (full indicator, memory indicator) and (if supported by the source) indication of bit-rate of the stream. The higher the bit rate, the better the audio quality will be.



Time display: elapsed playback time.
This display is not available for all services.



Indicates that it is possible to shift back by one level or selection using the  button.



Position indicator in a list, or when entering an address



Indicates that it is possible to confirm the entry or selection with the  button

ABC or
123 or
abc

Character input mode indicator

Access to Media Content via the Main Menu (Home Menu)

Main Menu (Home-Menu)

When you call up the Streaming Client by pressing the **SCL** button, the front panel screen displays a list containing the devices connected to the system, or accessible via the network, together with the Favourites folder, e.g.:

- USB / iPod *1)
- Internet Radio
- UPnP-AV Server (Media server) in the local network *2)
- Favorites



- i** *1) Only the selected USB input is displayed.
Use a long press on the **⊕** button on the front panel or a brief on the **⏏** button on the remote control to switch between the USB inputs.
- i** *2) To play back media files that are stored on PC's or NAS storage devices on your home network, a UPnP-AV server software must be installed on these devices to make the media content accessible through the network.

Selecting and Playing Media Content

You can now select a device or a service using the **▲** / **▼** buttons. The selected list item is shown enlarged, and can be called up by pressing the **OK** / **▶** button.

The content of the device is displayed in the form of a list. The individual list entries are followed either by a folder symbol (**📁**) or a note symbol (**🎵**).

You can now again move to the individual list points using the **▲** / **▼** buttons, and open them with the **OK** / **▶** button.

If the list entry you open is a folder, the screen displays the contents of the folder: you can now navigate further within the new folder.

If the entry is followed by a note symbol, this indicates that the content is playable (pieces of music, playlists, radio station etc.). If you open an entry of this type, its content will be played.

- i** The lists and music tracks you can see when you select a device vary according to the machine and the transferred data.

Alpha-Search (Letter Search Function)

When you are navigating through lists you can call up the **MP 3000 HV** letter search function at any time by briefly pressing the **▲▼** button. The screen now displays the message 'Search _'. While this is on the screen, enter up to five letters or numerals using the remote control handset; the letters assigned to the numeric buttons are printed below the buttons. To obtain a particular letter, press the appropriate button repeatedly until the correct letter appears on the screen. Before entering the next character you have to wait until the cursor is displayed again. After pressing the **v** button or after a brief delay with no further input the **MP 3000 HV** moves to the first entry in the list which starts with the characters you entered.

- i** If the text searched for is not found the best matching result will be shown. You can abort the search using the **—**-button.

Accessing Media Content using the Favourites List

The Favourites List

The Favourites list can be used to store your preferred Internet radio stations and the paths to your preferred music tracks. At any subsequent time you can then very quickly access these stations and tracks using the 'Favorites' entry in the Home Menu.







Adding Favourites to the List

If you are currently enjoying a particular Internet radio station, simply press the green  button on the F100 / FM100 handset: this adds the station to the Favourites list.





In principle you can also add pieces from a NAS server or a USB hard disc to your Favourites list, but we only recommend this if the content of the relevant storage medium is available at all times (e.g. permanently connected USB hard disc).

Calling up Favourites

Open the Favourites list using the  button, then select an entry from the list using the  /  buttons. Start the track or the station by pressing the  /  /  button.

Erasing Favourites

Entries are removed from the Favourites list by first selecting the entry to be erased using the  /  buttons, and then holding the red  button on the F100 / FM100 handset pressed in for several seconds.



Caution!



Erase the paths to files on USB hard discs or UPnP-AV servers from the Favourites list using the  button before you erase or move files.



Using Presets

Preset function



You can store Internet radio stations as **Presets** using the process familiar from FM radio. These stations can subsequently be called up directly using the numeric buttons on the F100 / FM100 remote control handset.

Storing a Preset

First select an Internet radio station (e.g. using the Home menu / Internet radio). When you hear the station, press the  button followed by a number  to . The station is now stored under this number.

It is possible to store a total of ten Presets under the numbers  to .

Calling up a Preset

Briefly press one of the numeric buttons  to . The associated Preset is now called up, and after a brief delay you will hear it.



Presets are particularly useful when the front panel screen is not in view, but you wish to call up stations (e.g. when operating the system from an adjacent room, or when operating it via a domestic control system).

Adding Internet Radio Stations

The lists of Internet radio stations displayed by the **MP 3000 HV** are very complete and comprehensive, but since new stations are constantly being added you may find that one of your favourite stations is not (yet) included in the Select lists.

In this case you can add the stations using the vTuner service (see also the Chapter '**vTuner Premium Service**'). The station added can then be accessed from the **MP 3000 HV** main menu under the Internet Radio / Added Stations point.

The MP 3000 HV as D/A Converter

General Information on D/A Converter Operation

The **T+A MP 3000 HV** can be used as a high-quality D/A converter for other devices such as satellite receiver, digital radio etc. which are fitted with poor-quality converters or no converter at all. The **MP 3000 HV** features two optical and four electrical digital inputs on the back panel to allow this usage. A USB-DAC input on the back panel permits to use the **MP 3000 HV** as D/A converter for computers.

i You can connect devices with electrical co-axial, BNC, AES-EBU or optical light-pipe output to the digital inputs of the **MP 3000 HV**. At the optical inputs Digital In 1 and Digital In 2 and the co-ax input Digital In 3 the **MP 3000 HV** accepts digital stereo signals conforming to the S/P-DIF norm, with sampling rates of 32 to 96 kHz. At the BNC and AES-EBU inputs Digital 4 1 to Digital In 3 the range of sampling rates is from 32 to 192 kHz.

The **MP 3000 HV** accepts digital stereo signals with sampling rates 44,1 192 kHz (up to 96 kHz for USB1 mode PC interfaces). If audio files with sample rates higher than 96 kHz shall be played back through the **MP 3000 HV** USB2 mode must be used. For this appropriate drivers must be installed on your computer first (see chapter. 'USB DAC operation in detail') and the **MP 3000 HV** must be set to USB 2 mode (see chapter '**Basic settings of the MP 3000 HV**').

D/A Converter Operation

Selecting a D/A Converter Source

Select the **MP 3000 HV** as listening source on your amplifier.

Choose the digital input to which you have already connected the source device which is to be played. by pressing the -button on the **FD100** remote or by turning the rotary source selector on the front panel of the **MP 3000 HV**.

As soon as the source device delivers digital music data, the **MP 3000 HV** automatically adjusts itself to the format and sampling rate of the signal, and you will hear the music.

Screen Display

i During D/A converter operations the **MP 3000 HV** integral screen displays the characteristics of the digital input signal.

USB DAC operation in detail

System-requirements

- Intel Core 2 @ 1,6 GHz or higher or a comparable AMD Processor.
- 1 GB RAM
- USB Interface
- Microsoft Windows 10, 8.1, 8, 7 or Windows XP
- or MAC OS 10.6.4 or higher until OS X 10.9
(OS X 10.10 only with disabled signature interrogation. For details please refer the support area on www.ta-hifi.com)

 MAC operating systems higher than OS X 10.10 no longer support the asynchronous USB 2 Mode of the USB audio chip used in the **MP 3000 HV**. In these cases, please use the USB 1 mode.

USB operation mode

The **MP 3000 HV** can be operated in **USB Audio Class 1** mode (USB Full Speed / USB 1.0) with all the listed operating systems without the need for a driver. However, in this case the system only caters for audio formats with a sampling frequency of up to 96 kHz.

Audio formats with a sampling frequency of more than 96 kHz (up to 192 kHz) can only be transferred in **USB Audio Class 2** mode (USB High Speed / USB 2.0). To play audio files of this type you must first install the appropriate driver for your operating system, and switch the **MP 3000 HV** to USB 2 mode (see section entitled '**System settings**').

 The drivers required, together with detailed installation instructions including information on audio playback via USB, are available for downloading from our website at <http://www.ta-hifi.com/mp3000hv-software>

Settings

A number of system settings have to be altered if you wish to operate **MP 3000 HV** with your computer. These changes must be made regardless of the operating system and the USB mode. The installation instructions provide detailed information on how and where the settings are to be changed.

Notes on software

 By default, the operating systems listed above do not support 'native' music playback. This means that the PC always converts the data stream to a fixed sample rate, regardless of the sample rate of the file to be played. Separate software is available - e.g. J. River Media Center or Foobar - which prevents the operating system converting the sample rate. The installation instructions included in the driver package contain further information on audio playback via USB.

Notes on operation

 To prevent fail functions and system crashes of your computer and the playback program, please note the following:

- USB 2 mode: Install the driver before you use the **MP 3000 HV** for the first time.
- Use only drivers, streaming methods (e.g. WASAPI, Directsound) and playback software which are compatible to your operating system and between each other.
- Never connect or disconnect the USB connection while the system is running.
- The USB mode should never be switched over while the **MP 3000 HV** is connected and the computer is running.

Installation

Using the system for the first time

Safety notes

This section describes all those matters which are of fundamental importance when setting up and first using the equipment. This information is not relevant in daily use, but you should nevertheless read and note it before using the equipment for the first time.

Back panel connections

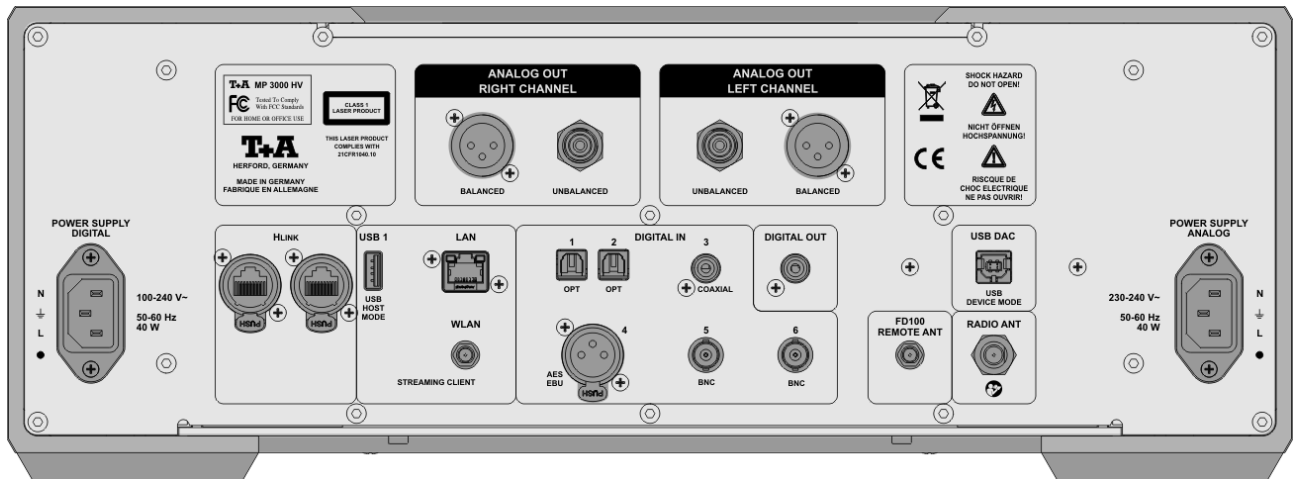

ANALOG OUT

BALANCED

The symmetrical XLR output delivers analogue stereo signals with a fixed level. It can be connected to the CD-input (line input) of any stereo pre-amplifier, integrated amplifier or receiver.



If both types of connection are present on the connected amplifier, we recommend the symmetrical option to obtain the best possible sound quality.

UN-BALANCED

The unbalanced RCA output of the **MP 3000 HV** delivers analogue stereo signals with a fixed level. It can be connected to the CD-input (line input) of any stereo pre-amplifier, integrated amplifier or receiver.

H LINK

Control input / output for **T+A H LINK** – systems:

Both sockets are equivalent – one is used as input, the other one serves as output towards other **H LINK** devices.

USB IN

Socket for a USB memory stick or external hard discs

Files from a medium connected to this socket are reproduced via the Streaming Client (SCL). Only audio files can be played in this way.

The storage medium must be formatted using the FAT16 or FAT32 file system. The USB storage medium can be powered directly via the USB port provided that its current drain is in accordance with the USB norm. Normalised 2.5" USB hard discs can be connected directly, i.e. without a separate mains PSU.

LAN

Socket for connection to a wired LAN (Ethernet) home network.



If a LAN cable is connected this will have priority over wireless WLAN networks. The WLAN module of the **MP 3000 HV** will automatically be disabled.

WLAN

Input socket for WLAN antenna



Automatic Activation of the WLAN Module

After powering on the **MP 3000 HV** detects if it is connected to a wired LAN Network. If no wired LAN connection is found, the **MP 3000 HV** will automatically activate its WLAN module and it will try to get access to your WLAN network.

DIGITAL IN	Inputs for digital source devices with optical, co-axial (RCA / BNC) or AES-EBU digital outputs.
	<p>i At its optical (Dig 1 und Dig 2) and RCA (Dig 3) digital inputs the MP 3000 HV accepts digital stereo signals (S/P-DIF signals) with sampling rates from 32kHz up to 96 kHz. At the BNC and AES-EBU inputs (Dig 4 ... Dig 6) sampling rates in the range 32 to 192 kHz are supported.</p> <p>i If digital audio signals with sampling rates above 96 kHz from a source with RCA output shall be converted, these signals can be connected to one of the BNC inputs with the help of the RCA to BNC adapter from the MP 3000 HV accessories.</p>
DIGITAL OUT	<p>Digital co-axial output for connection to an external digital/analogue converter with an co-axial cable.</p> <p>i It is not always possible to produce a digital version for all media, as in some cases the original contains copy protection measures which prevent this.</p>
FD 100 REMOTE ANT	Socket for connecting the aerial of the FD100 remote control handset.
RADIO ANT	The MP 3000 HV features a 75 Ω aerial input FM ANT , which is suitable both for a normal domestic aerial and a cable connection. For first-class reception quality a high-performance, professionally installed aerial system is indispensable.
USB DAC	<p>Socket for connecting a PC or MAC computer.</p> <p>At this input the MP 3000 HV accepts digital stereo signals with sampling rates of 44.1 to 192 kHz (USB 1 transfer max. 96 kHz).</p> <p>i If the MP 3000 HV is connected to a PC or MAC computer, and is required to convert audio files with a sampling frequency of more than 96 KHz (max. 192 kHz), then you must first install the appropriate driver on the computer (see section entitled 'USB DAC operation in detail'); the MP 3000 HV must also be switched over to USB 2 (see section entitled 'System settings').</p>
Mains input	<p>i To avoid any coupling of unwanted noise signals from the digital power supply to the analog power supply of the MP 3000 HV, the digital and analogue power supplies are located in separate shielded compartments on the left and right sides of the device. For best possible separation the power supplies have their own separate power supply sockets.</p> <p>Always connect both mains sockets to the mains supply when operating the MP 3000 HV.</p>
Digital power supply	The mains lead for the digital power supply is plugged into this socket.
Analogue power supply	<p>The mains lead for the analogue power supply is plugged into this socket.</p> <p>For correct connections refer to the sections 'Installation and wiring' and 'Safety notes'.</p>

Installation and wiring



Carefully unpack the unit and store the original packing material carefully. The carton and packing are specially designed for this unit and will be needed again if you wish to move the equipment at any time.

If you have to transport the device, it must always be carried or sent in its original packaging in order to prevent damage and defects.

The device is extremely heavy - caution is required when unpacking and transporting it. Always lift and transport the device with two persons.

Legal requirements pertaining to the lifting of heavy loads prohibit the transport of the device by women.

Ensure that you have a firm, secure hold on the device. Do not let it fall. Wear safety footwear when moving the device. Take care not to stumble. Ensure an unobstructed area of movement by removing obstacles and possible hindrances from the route.

Take care when lowering the device! To avoid your fingers being crushed, ensure that they are not trapped between the device and the support surface.

If the unit gets very cold (e. g. when being transported), condensation may form inside it. Please do not switch it on until it has had plenty of time to warm up to room temperature, so that any condensation evaporates completely.

If the device has been in storage, or has not been used for a protracted period (> two years), it is essential to have it checked by a specialist technician before re-use.

Before placing the unit on sensitive laquer or wood surfaces please check the compatibility of the surface and the unit's feet on a non visible point and if necessary use an underlay. We recommend a surface of stone, glass, metal or the like.

The unit should be placed on a rigid, level base (See also chapter "**Safety notes**"). When placing the unit on resonance absorbers or anti-resonant components make sure that the stability of the unit is not reduced.

The unit should be set up in a well ventilated dry site, out of direct sunlight and away from radiators.

The unit must not be located close to heat-producing objects or devices, or anything which is heat-sensitive or highly flammable.

Mains and loudspeaker cables, and also remote control leads must be kept as far away as possible from signal leads and antenna cables. Never run them over or under the unit.

Notes on connections:

A complete connection diagram is shown in '**Appendix A**' .

- Be sure to push all plugs firmly into their sockets. Loose connections can cause hum and other unwanted noises.
- When you connect the input sockets of the amplifier to the output sockets on the source devices always connect like to like, i. e. '**R**' to '**R**' and '**L**' to '**L**'. If you fail to heed this then the stereo channels will be reversed.
- The device is intended to be connected to mains outlet with protective earth connector. Please connect it only with the mains cables supplied to properly installed mains outlets with protective earth connector.
- To achieve maximum possible interference rejection the mains plug should be connected to the mains socket in such a way that phase is connected to the mains socket contact marked with a dot (●). The phase of the mains socket can be determined using a special meter. If you are not sure about this, please ask your specialist dealer.

We recommend the use of the **T+A 'POWER THREE'** ready-to-use mains lead in conjunction with the '**POWER BAR**' mains distribution panel, which is fitted with a phase indicator as standard.

When you have completed the wiring of the system please set the volume control to a very low level before switching the system on.

The screen on the **MP 3000 HV** should now light up, and the unit should respond to the controls.

If you encounter problems when setting up and using the amplifier for the first time please remember that the cause is often simple, and equally simple to eliminate. Please refer to the section of these instructions entitled '**Trouble shooting**'.

Loudspeaker and signal cables

Loudspeaker cables and signal cables (inter-connects) have a significant influence on the overall reproduction quality of your sound system, and their importance should not be under-estimated. For this reason **T+A** recommends the use of high-quality cables and connectors.

Our accessory range includes a series of excellent cables and connectors whose properties are carefully matched to our speakers and electronic units, and which harmonise outstandingly well with them.

For difficult and cramped situations the **T+A** range also includes special-length cables and special-purpose connectors (e. g. right-angled versions) which can be used to solve almost any problem concerning connections and system location.

Mains cables and mains filters

The mains power supply provides the energy which your sound system equipment needs, but it also tends to carry interference from remote devices such as radio and computer systems.

Our accessory range includes the specially shielded '**POWER THREE**' mains cable and the '**POWER BAR**' mains filter distribution board which prevent electro-magnetic interference from entering your Hi-Fi system. The reproduction quality of our systems can often be further improved by using these items.

If you have any questions regarding cabling please refer to your specialist **T+A** dealer who will gladly give you comprehensive expert advice without obligation. We would also be happy to send you our comprehensive information pack on this subject.

Care of the unit

Disconnect the mains plug at the wall socket before cleaning the case.

The surfaces of the case should be wiped clean with a soft, dry cloth only.

Never use solvent-based or abrasive cleaners!

Before switching the unit on again, check that there are no short-circuits at the connections, and that all cables are plugged in correctly.

Storing the unit

If the device has to be stored, place it in its original packaging and store it in a dry, frost-free location. Storage temperature range 0...40 °C

Safety notes

Installation

For your own safety please consider it essential to read these operating instructions right through, and observe in particular the notes regarding setting up, operation and safety.

Please consider the weight of the device. Never place the device on an unstable surface; the machine could fall off, causing serious or even fatal injury. Many injuries, especially to children, can be avoided if the following simple safety precautions are observed:

- Use only such items of furniture which can safely bear the weight of the device.
- Ensure that the device does not project beyond the edges of the supporting furniture.
- Do not place the device on tall furniture (e.g. bookshelves) without securely anchoring both items, i.e. furniture and device.
- Explain to children the hazards involved in climbing on furniture to reach the device or its controls.

When installing the unit on a shelf or in a cupboard it is essential to provide an adequate flow of cooling air, to ensure that the heat produced by the unit is dissipated effectively. Any heat build-up will shorten the life of the unit and could be a source of danger. Be sure to leave free space of 10 cm around the unit for ventilation.

If the system components are to be stacked then the amplifier must be the top unit. Do not place any object on the top cover.

The unit must be set up in such a way that none of the connections can be touched directly (especially by children). Be sure to observe the notes and information in the section '**Installation and Wiring**'.

Connection

The terminals marked with the -symbol can carry high voltages.

Always avoid touching terminals and sockets and the conductors of cables connected to them. Unless ready-made cables are used, all cables connected to these terminals and sockets must always be deployed by a trained person.

Power supply

The device is intended to be connected to mains outlet with protective earth connector. Please connect it only with the mains cable supplied to a properly installed mains outlet with protective earth connector.

The power supply required for this unit is printed on the mains supply socket. The unit must never be connected to a power supply which does not meet these specifications. If the unit is not to be used for a long period disconnect it from the mains supply at the wall socket.

Mains leads / Mains plug

Mains leads must be deployed in such a way that there is no danger of damage to them (e. g. through persons treading on them or from furniture). Take particular care with plugs, distribution panels and connections at the device.

Unplugging the mains plug will disconnect the device from the mains for service and repair. Please make sure that the mains plug is easily accessible.

Enclosure openings

Liquid or particles must never be allowed to get inside the unit through the ventilation slots. Mains voltage is present inside the unit, and any electric shock could cause serious injury or death. Never exert undue force on mains connectors.

Protect the unit from drips and splashes of water; never place flower vases or fluid containers on the unit.

Do not place naked flame sources, such as candle lights on the device.

Supervision of device operation

Like any other electrical appliance this device should never be used without proper supervision. Take care to keep the unit out of the reach of small children.

Service, Damage

The case should only be opened by a qualified specialist technician. Repairs and fuse replacements should be entrusted to an authorised **T+A** specialist workshop. With the exception of the connections and measures described in these instructions, no work of any kind may be carried out on the device by unqualified persons.

If the unit is damaged, or if you suspect that it is not functioning correctly, immediately disconnect the mains plug at the wall socket, and ask an authorised **T+A** specialist workshop to check it.

Over voltage

The unit may be damaged by excess voltage in the power supply, the mains circuit or in aerial systems, as may occur during thunderstorms (lightning strikes) or due to static discharges.
Special power supply units and excess voltage protectors such as the **T+A 'Power Bar'** mains distribution panel offer some degree of protection from damage to equipment due to the hazards described above.
However, if you require absolute security from damage due to excess voltage, the only solution is to disconnect the unit from the mains power supply and any aerial systems.
To avoid the risk of damage by overvoltages we recommend to disconnect all cables from this device and your HiFi system during thunderstorms.
All mains power supply and aerial systems to which the unit is connected must meet all applicable safety regulations and must be installed by an approved electrical installer.

Approved usage

The device is designed to operate in a temperate climate. The range of permissible operating temperatures is +10 ... +35°C. This device is designed exclusively for reproducing sound and/or pictures in the domestic environment. It is to be used in a dry indoor room which meets all the recommendations stated in these instructions.
Where the equipment is to be used for other purposes, especially in the medical field or any field in which safety is an issue, it is essential to establish the unit's suitability for this purpose with the manufacturer, and to obtain prior written approval for this usage.

Approval and conformity with EC directives

In its original condition the unit meets all currently valid European regulations. It is approved for use as stipulated within the EC.
By attaching the CE symbol to the unit **T+A** declares its conformity the EC directives (See page 2) and the national laws based on those directives.
The original, unaltered factory serial number must be present on the outside of the unit and must be clearly legible! The serial number is a constituent part of our conformity declaration and therefore of the approval for operation of the device. The serial numbers on the unit and in the original **T+A** documentation supplied with it (in particular the inspection and guarantee certificates), must not be removed or modified, and must correspond.
Infringing any of these conditions invalidates **T+A** conformity and approval, and the unit may not be operated within the EC. Improper use of the equipment makes the user liable to penalty under current EC and national laws.
Any modifications or repairs to the unit, or any other intervention by a workshop or other third party not authorised by **T+A**, invalidates the approval and operational permit for the equipment.
Only genuine **T+A** accessories may be connected to the unit, or such auxiliary devices which are themselves approved and fulfil all currently valid legal requirements.
When used in conjunction with auxiliary devices or as part of a system this unit may only be used for the purposes stated in the section '**Approved usage**'.

Disposing of this product



The only permissible method of disposing of this product is to take it to your local collection centre for electrical waste.

FCC Information to the user

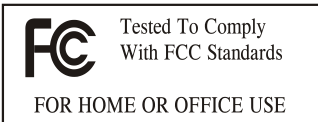

(for use in the United States of America only)

Class B digital device – instructions:
Note: This equipment has been tested and found to comply with the limits for a Class B digital device, pursuant to Part 15 of the FCC Rules. These limits are designed to provide reasonable protection against harmful interference in a residential installation. This equipment generates, uses and can radiate radio frequency energy and, if not installed and used in accordance with the instructions, may cause harmful interference to radio communications. However, there is no guarantee that interference will not occur in a particular installation. If this equipment does cause harmful interference to radio or television reception, which can be determined by turning the equipment off and on, the user is encouraged to try to correct the interference by one or more of the following measures:
- Reorient or relocate the receiving antenna.
- Increase the separation between the equipment and receiver.
- Connect the equipment into an outlet on a circuit different from that to which the receiver is connected.
- Consult the dealer or an experienced radio/TV technician for help.

Network Configuration

General Information

The **MP 3000 HV** can be operated in wired LAN networks (*Ethernet LAN* or *Powerline LAN*) or in wireless networks (*WLAN*).

If you wish to use your **MP 3000 HV** in your home network, you must first enter the necessary network settings on the **MP 3000 HV**. This includes entering the network parameters such as the IP address etc. both for wired and wireless operation. If you wish to use a wireless connection, a number of additional settings for the WLAN network also have to be entered.

Please refer to the Chapter '**Glossary / Additional Information**' and '**Network Terms**' for additional explanations of terminology relating to network technology.

i In the following sections we assume that a working home network (cable network of WLAN network) **with router and (DSL) Internet access is present**. If you are unclear about some aspect of installing, setting up and configuring your network, please address your queries to your network administrator or a network specialist.

i High-resolution audio files via network

The **MP 3000 HV** can also play back high-resolution up to 192 kHz / 24-bit audio formats in the FLAC and WAV formats. A WLAN connection is not generally sufficient to handle the large quantities of data. If you wish to play back high-resolution audio files via a network connection, please use a cable network exclusively.

Compatible hardware and UPnP servers

The marketplace offers a vast number of routers, NAS devices and USB hard discs made by a very wide range of manufacturers. **T+A** equipment is generally compatible with other makes of machine which bear the UPnP label. A list of devices which **T+A** has checked for compatibility can be found on the Internet at: http://www.taelektroakustik.de/fileadmin/software/e-serie/MP_HW_KOMP.pdf

Network Configuration Menu

All network settings are entered in the Network Configuration menu. This menu will vary slightly in appearance depending on the type of your network, i.e. whether you have a wired (LAN) or wireless (WLAN) network.

If in the Network Configuration Menu the entry 'Network IF Mode' is set to 'auto', the **MP 3000 HV** will check automatically if a LAN connection to a network is present. If a LAN connection is found, the machine will assume that this is to be used, and displays the network configuration menu for LAN networks.

If no LAN network is connected, the **MP 3000 HV** activates its WLAN module and displays the WLAN configuration menu when you call up the configuration menu. The menu for a WLAN network includes a number of additional menu points. The following sections explain how to use the menu, and the meaning of the individual menu points.

i The Network IF Mode 'auto' is the default factory setting. In case of problems in combination with your hardware this automatic function can be switched to a fixed operation mode, e.g. only LAN.

Opening the Network Configuration Menu

Operating the Menu, Changing and Storing IP Addresses

Closing the Menu

Interrupting the Menu without Storing the Settings

First select the **MP 3000 HV** Streaming Client function by pressing the **SCL** button.
Open the configuration menu with a long press on the **SRC** button on the F100 / FM100 remote control handset. You should now see the configuration menu on the front panel screen.

Use the **▲** / **▼** buttons in the menu to select the network parameter to be changed, and activate the entry with the **OK** button.

You can now change the setting using the following buttons, depending on the type of setting:

◀ / **▶** button for simple selection (ON / OFF)

Numeric buttons **0** to **9** for entering IP addresses

Alpha-numeric input for entering text

When the setting process is complete, or when you have entered the complete address, press the **OK** button to confirm your action.

Alpha-numeric entry

At certain points, e.g. for entering server names or passwords, it is necessary to input series of characters (strings). At such points you can enter letters, numbers and special characters by repeatedly pressing the numeric buttons on the F100 / FM100 remote control handset, as when writing SMS news. The assignment of letters to the buttons is printed below the buttons. Special characters can be accessed using the **0** and **1** buttons:

0	0 + - * / ^ = { } () [] < >
1	. , ? ! : ; ' \ " ' _ @ \$ % & # ~

Use the blue **▲▼** button for toggling between numbers, capitals and lower-case letters. The bottom line of the screen shows which input mode is currently selected.

i At certain points (e.g. DNS server name) it is possible to enter both an alpha-numeric string and an IP address. At these points an IP address should be entered like a string (with separating dots as special characters). In this case an automatic check for valid address ranges (0 ... 255) is not carried out.

Once you have correctly set all the parameters, select the menu item **'Save and Restart'**, then press the **OK** button. This action causes the **MP 3000 HV** to accept the settings, and the machine restarts with the new network settings. After the restart you should see the available network media sources (Internet radio, UPnP-AV server, etc.) displayed in the main menu.

At any time you can leave the network configuration menu without making any changes to the network settings: this is done by pressing the **■** button, which takes you to the menu item **'Exit without saving'**. Pressing the **OK** button at this juncture interrupts and closes the menu.

The Configuration for a Wired Ethernet LAN or Power-Line LAN connection

Setting the Parameters for a Wired Network

- Connect the **MP 3000 HV** to an operational network or Power-Line modem using the LAN socket on the back panel.
- Switch the **MP 3000 HV** on, and select the Streaming Client function by pressing the **SCL** button.
- Call up the Configuration menu as described above. You should now see the menu reproduced below, displaying the network parameters. In the title line the message 'LAN' should appear, indicating that the machine is connected to a wired LAN. If you see 'WLAN' at this point instead, please check your network connection, and ensure that the network is switched on and operational.
- You can now select the individual menu points and adjust them to match your network conditions. The illustration below shows the possible button inputs after each menu item.

Network Parameter (LAN)		Possible entries
MAC	00:0e:9b:cc:a4:35	none
→ DHCP	Off	◀ / ▶
Device IP	192.168.0.10	(0 ... 9)
IP mask	255.255.255.0	(0 ... 9)
Gateway IP	192.168.0.1	(0 ... 9)
DNS 1	192.168.0.1	(0 ... 9, A ... Z)
DNS 2	0.0.0.0	(0 ... 9, A ... Z)
Proxy	XXX	◀ / ▶
Proxy IP	192.168.0.1	(0 ... 9, A ... Z)
Proxy port	8080	(0 ... 9)
Device Name	TA Music Player	(0 ... 9, A ... Z)
Network IF Mode	Auto	◀ / ▶
Save and restart	Apply	OK
Exit without saving	Apply	OK

- ◀ / ▶: Switching ON / OFF
 (0...9): Numeric input, separating dots are automatically generated; input limited to valid addresses
 (0...9, A...Z): Alpha-numeric input and special characters. IP - separating dots must be entered as special characters.

i The parameters illustrated above are only typical values. Addresses and settings may require different values for your network.

Menu Item	Description
MAC	The MAC address is a hardware address which uniquely identifies your machine. The address displayed is determined by the manufacturer, and cannot be altered.
DHCP state	<p>ON If your network includes a DHCP server, please select the ON setting at this item. In this mode an IP address is automatically assigned to the MP 3000 HV by the router. The screen shows only the MAC address and the message DHCP state ON. In this case the address input fields shown in the illustration do not appear in the menu.</p> <p>OFF If your network does not include a DHCP server, please select the OFF setting. In this mode you must configure the following network settings manually. Please ask your network administrator for the addresses to be entered for your network.</p>
Device IP	IP address of the MP 3000 HV
IP mask	Network mask
Gateway IP	IP address of the router
DNS 1	Name / IP of the name server (optional)
DNS 2	Alternative name server (optional)
Proxy state	ON if a proxy server is present, otherwise OFF
Proxy IP	Address of the proxy server
Proxy port	Port number of the proxy server
Device Name	Name of the device which appears in the network
Network IF Mode	Networksetting: only WLAN, only LAN or automatic setting
Save and Restart	Stores the network parameters, and restarts the MP 3000 HV with the new settings.
Exit without saving	Closes the menu: data already entered is discarded.

The Configuration for a WLAN connection

Setting the Parameters for a Radio Network

- Connect the WLAN aerial (supplied) to the **MP 3000 HV** WLAN aerial socket, and ensure that no cable is attached to the **MP 3000 HV** LAN socket.
- Switch the **MP 3000 HV** on, and select the Streaming Client function by pressing the **SCL** button.
- Now call up the Configuration menu as described above: with a long press on the **SRC** button. You should now see the menu reproduced below, displaying the network parameters.

Network Parameter (WLAN)		
MAC	00:0e:9b:cc:a4:35	
→ WLAN configuration	start	none
DHCP	Off	◀ / ▶
Device IP	192.168.0.10	(0 ... 9)
IP mask	255.255.255.0	(0 ... 9)
Gateway IP	192.168.0.1	(0 ... 9)
DNS 1	192.168.0.1	(0 ... 9, A ... Z)
DNS 2	0.0.0.0	(0 ... 9, A ... Z)
Proxy	XXX	◀ / ▶
Proxy IP	192.168.0.1	(0 ... 9, A ... Z)
Proxy port	8080	(0 ... 9)
Device Name	TA Music Player	(0 ... 9, A ... Z)
Network IF Mode	Auto	◀ / ▶
Save and restart	Apply	OK
Exit without saving	Apply	OK

Searching for and Selecting the Network

First select the menu item **'WLAN configuration start'**, and activate it by pressing the **OK** button.

A menu appears showing these points:

- Rescan - initiates new search for accessible radio networks
- Set manually - adding a WLAN manually

After a brief delay the networks present in the vicinity are listed on the screen.

List of WLANs
→ Rescan
Set manually
XXXXX (name of network)
(1/3)

You can use the 'Rescan' function to start a new search for networks present in the vicinity.

Please select one of the networks located, and activate it by pressing the **OK** button.

Entering the Password (for encoded networks)

WLAN configuration	
→ Passphrase
Save WLAN settings	Apply
(1/2)	

If your network is encoded, the window illustrated above now appears. Please enter the network password and confirm the entry by pressing **OK**. Now select the item 'Save WLAN settings' and confirm with **OK**.



If a WEP code is used, the password must be entered as a hexadecimal code (0 - 9, A - F).

Please enter the settings for the remaining network parameters as described earlier in the section entitled **'Setting the Parameters for a Wired Network'**.

Finally select the menu item 'Save and Restart', and press the **OK** button; this action accepts the settings, and restarts the **MP 3000 HV** with the new settings.

Storing Network Settings and Restarting

**Special case:
Manual Network Entry**

The **MP 3000 HV** automatically searches for accessible radio networks, and lists them when you call up the menu item 'WLAN Configuration'. However, the **MP 3000 HV** can only locate networks which broadcast their SSID network identity. For security reasons many radio networks do not transmit the SSID (if you are not sure about this, ask your network administrator). In such cases the network cannot be found and displayed automatically, i.e. it must be set up manually. This is the purpose of the menu item 'Set Manually'. If you select this menu item, you will see the input window reproduced below; you can enter the parameters for your network at this point.

WLAN configuration

→ Network Name (SSID)
Security	NONE
Passphrase
Save WLAN settings	Apply

(1/4)

After successfully entering all the data, please select the item 'Save WLAN Settings', and confirm by pressing the **OK** button. Your **MP 3000 HV** now accepts the data you have entered relating to the WLAN network, and moves on to the subordinate menu in which you can set the remaining network parameters, as described earlier in the section entitled '**Setting the Parameters for a Wired Network**'.

You can now leave the Configuration menu by selecting the menu item 'Save and restart'.

The vTuner Premium Service

The list of radio stations displayed by your **MP 3000 HV** is prepared by an Internet Service Provider, and transferred to your machine by data transfer. You can expand and edit the 'Favourite Groups' and 'Added Stations' list to suit your preferences via the Internet portal of your service provider, using the main menu item 'Internet Radio'. This is the procedure:

Open your Internet browser and call up the following web address:
<http://ta.vtuner.com>

The first time you register you should enter the MAC address (ID#) of your **MP 3000 HV**; the MAC address provides unique identification of your machine. The MAC address can be found in the Configuration menu (hold the **SRC** button pressed in, during Streaming Client operation), and consists of six pairs of characters, e.g.: 00:0e:9b:cc:a4:35. You do not need to enter the separating colons when you enter this data. MAC addresses are in hexadecimal format, i.e. the address consists only of the letters a to f, and the numbers 0 to 9.

Confirm your entry.

The screenshot shows the vTuner website interface. At the top, there are language selection options (Home Language) and a 'My Preferences' link. The main header features the vTuner logo and a navigation menu with 'Logout', 'STATUS', '9754 Stations Available', '9649 Podcasts', and 'New Stations'. Below the header, there are sections for 'My Favourite Groups' (with a 'Trance' group) and 'My Added Stations' (with a station named 'Stellar Attraction' from Great Britain). A search bar is available, and there are options to 'Add Another Station'. The main content area is titled 'Browse by Format, Location or Language' and contains three columns of links for browsing stations and podcasts by format, location, and language. The 'Music' section lists various genres like Adult Contemporary, Alternative, Ambient, Big Band, Bluesgrass, Blues, Celtic, Christian Contemporary, Christian Rock, Classic Rock, Classical, College, Country, and Dance. The 'Talk' section lists Business News, Comedy, Government, and News. Other categories include Electronics, Folk, Gospel, Hard Rock, Hip Hop, Holiday, Jazz, Latin Hits, New Age, Oldies, Public, R&B, Reggae, and Rock. World music categories like Show Tunes, Smooth Jazz, Soft Rock, Soundtracks, Top 40, Variety, World, World Asia, World Europe, World Hawaiian, World India, World Middle East, World Native American, and World Tropical are also listed.

You must register with vTuner in order to be able to use the service; you can register via your e-Mail address and a password. Please follow the instructions stated by the service provider.

Now you can select radio stations from the comprehensive inventory provided by vTuner, and store them in lists. The lists are transferred to your **MP 3000 HV** automatically via your Internet connection. Shortly after you have edited lists on the vTuner page, or stored new stations, you will find that they are available on your **MP 3000 HV**.

i Notes regarding Internet Radio:

- Not all stations are always accessible
 - Not all stations transmit 24 hours
 - Stations are no longer accessible
 - Capacity exhausted
- Transmission breaks off
 - (Internet) network problems
 - Server capacity exhausted

Setting up new Internet Radio Stations

On the vTuner Internet site you can also set up new stations which are not (yet) included in the Select lists. This is accomplished by registering with vTuner and logging on. Click on the item 'My Added Stations'. An input mask appears in which you can enter the data for your station. After a brief period you will be able to access the newly set-up station via the menu system of your **MP 3000 HV**. You will find the station under Internet Radio / Added Stations.

Finding a Station URL



You require the URL (Internet address) of any radio station you wish to set up on the vTuner service. You will generally find the URL on the station's website. Another method of finding the URL is to search for it using an Internet searching service such as Shoutcast (www.shoutcast.com). Once you have found your station, click on the 'Tune In' switch: this will normally open your media player, and the station should play. In most cases you can set Media Player to display the 'Streaming Properties'. For example, using the popular Winamp Player, simply right-click on the entry for the currently playing station in the player's Playlist window. A menu now opens, and clicking on the item 'View File Info' opens an information box which displays the streaming properties including the URL.

Pairing the FD 100 Radio Remote Control

General

The **MP 3000 HV** is designed for use with the **FD 100** bi-directional radio control handset. The **FD 100** features an integral full-colour screen which provides a convenient means of controlling virtually all the **MP 3000 HV**'s functions, even when there is no direct line-of-sight contact with it. The handset can also display information relating to the selected source or the medium currently playing.

Connecting the radio aerial





Since the **FD 100** operates by a radio link, an aerial must be connected to the **MP 3000 HV**. This is plugged into the socket on the **MP 3000 HV** marked 'Remote ANT' (please see wiring diagram). The aerial should be free-standing in order to obtain maximum effective range.



Please use one of the WLAN aerials supplied in the set; the aerials are identical.

Pairing the FD 100

Before the **MP 3000 HV** can be controlled using the **FD 100**, the remote control handset must first be registered to the **MP 3000 HV**. This process is known as pairing, and only has to be carried out once. The procedure is as follows:

- Briefly touch the  sensor button on the **MP 3000 HV** front panel to call up the menu. Then select the menu item '**FD 100** pairing'.
- Activate this selection by pressing the rotary selector knob and confirm the pairing procedure by pressing the knob until the display message changes to. '**Waiting for FD 100**'.
- The pairing now function remains active for thirty seconds. Carry out the following steps within this time.
- Locate the  button on the **FD 100** and hold it pressed in to open the **FD 100**'s System Settings menu.
- Now select the 'Start pairing' item, and press the  button: the remote control handset automatically seeks the **MP 3000 HV**.
- Once the device is found, you will see in the display header the on-screen message 'Pairing successful'. At the same time changes the menu entry of the **MP 3000 HV** to 'Done'. If you wish, you can change the name of the device at this point (e.g. 'Living room').
- Confirm the name with the  button.
- For faster access the **MP 3000 HV** can also be assigned to a Hotkey; this is the next step (see **FD 100** operating instructions).
- Select one - or optionally none - of the 'F' buttons, and confirm your choice by pressing the  button.
- The **FD 100** is now paired with the **MP 3000 HV**, and is ready for use.



For detailed information on using the **FD 100** please refer to the operating instructions supplied with the remote control handset.

Glossary / Supplementary Information

CD	<p>Compact Discs (CD) are digital data media which need to be handled carefully. These are the basic rules:</p> <ul style="list-style-type: none">• The surface of a CD should only ever be cleaned with a soft dry cloth. Never wipe it in a circular motion, i. e. along the tracks.• Never use petrol, paint thinners, disc cleaners or similar materials on compact discs.• CDs must be handled carefully in order to avoid serious damage to the surface. Severely scratched surfaces, writing on the disc or applying self-adhesive labels may result in the CD player being unable to read the data.• CDs should not be heated or bent. This means that they should be stored in a position and attitude which meet these requirements.
H LINK	<p>Control interface for remote control of T+A systems. The CD player / MP 3000 HV receives the infra-red remote control signals and passes them on to the power amplifier and to the source devices.</p>
Field strength	<p>The electrical field strength is a measurement of the level (strength) of the radio signal supplied by the antenna. In general terms, the higher the field strength of the tuned station, the better the reception quality. Signal field strength is determined primarily by the following factors:</p> <ol style="list-style-type: none">1. Distance from radio transmitter2. Obstacles (mountains etc.) between transmitter and receiver3. Transmitter output power4. Quality and direction of the receiver antenna system. <p>Point 4 is of crucial importance here. It is impossible to obtain good reception with a poor aerial system.</p> <p>Your specialist T+A dealer will be glad to advise you on the subject of installing or improving your aerial system, taking your specific local reception conditions into account.</p>
FM = Frequency Modulation	<p>All FM radio transmitters use the 'FM' method of modulation. This technology provides maximum possible sound quality and interference suppression.</p>
Cable Network	<p>When the MP 3000 HV's tuner was being developed the requirements of the European cable network were given high priority. The tuner copes very well with excessive signal levels, and its high selectivity avoids many of the problems involved with cable operation, without any reduction in reproduction quality.</p>
MIX	<p>In MIX-Mode (Shuffle) the titles of a CD or the titles of a program are played back in a random order.</p>
Muting = Hiss suppression	<p>The MP 3000 HV features automatic hiss suppression which cuts out the annoying hissing sound between radio stations, and suppresses very weak stations which cannot be received with reasonable quality.</p>
Preset = station memory	<p>The MP 3000 HV can store all the settings for stations, any of which can be recalled simply by pressing a button.</p>
RDS = Radio Data System 	<p>Many radio stations broadcast supplementary digital information simultaneously with the programme. The MP 3000 HV is equipped with an RDS decoder, and displays the station name of RDS transmitters in plain text on its alpha-numeric screen. This is a great advantage when searching for particular stations.</p>
SINGLE CD	<p>A 'Single CD' is a CD with smaller diameter and a shorter play time. The MP 3000 HV can play back CD singles. Please insert these discs into the depression at the center of the disc tray.</p>
Standby	<p>The MP 3000 HV can be switched on from the Standby state from the remote control handset.</p>
Seek threshold	<p>The seek threshold is the minimum field strength value at which the automatic station search process halts. It is set at a level which ignores very weak transmitters.</p>

Technical description

Digital filters / Oversampling

Oversampling

The audio data on for example CDs is stored at a sampling rate of 44.1 - i. e. for each second of music 44.100 sampled values are available for each channel. In the **MP 3000 HV** the audio data read from the CD is „multiplied“ to a higher sampling rate (352,8 kHz) before it is converted back into analogue music signals. This process delivers a very much better, more finely graduated signal to the converter, which can then be converted with correspondingly higher precision. The raised sampling rate is a calculating process for which there are many different mathematical methods. In almost all digital audio devices which exploit the advantages of increased digital sampling rate a process known as a FIR filter is employed for this purpose. At **T+A** we have been carrying out research for more than ten years, aimed at improving the oversampling process, because the standard FIR method has one drawback to set against its indisputable advantages: it adds small pre- and post-echoes to the music signals. At **T+A** we have developed mathematical processes (known as Bezier polynomial interpolators) which do not share this disadvantage. For this reason they should sound better and more natural than the usual standard process. Since the calculating procedure employed by us is considerably more complex than the standard method, the **MP 3000 HV** features a high-performance digital signal processor (DSP) which carries out the over-sampling process with immense precision (56 bit) using special algorithms developed by **T+A**.

The freely programmable DSP which we use is capable of carrying out the oversampling process using any method of calculation. For this reason we have implemented a slightly modified Bezier process (filters 3) in the **MP 3000 HV** in addition to the pure Bezier process (filter 4), together with two variants of the standard process (filter 1 and filter 2). For more information on the different processes please refer to the next section. You can switch between the various algorithms, then decide for yourself which of the filters gives the results you prefer.

FIR long (Standard FIR Filter)

The long FIR filter is the standard oversampling process in digital technology, offering extremely linear frequency response, very high damping, linear phase characteristics and constant group delays. The disadvantage is the pre- and post-echoes which are added to the signal. These „time range errors“ tend to affect the music signal's dynamics, precision and naturalness, and reduce spatial orientation.

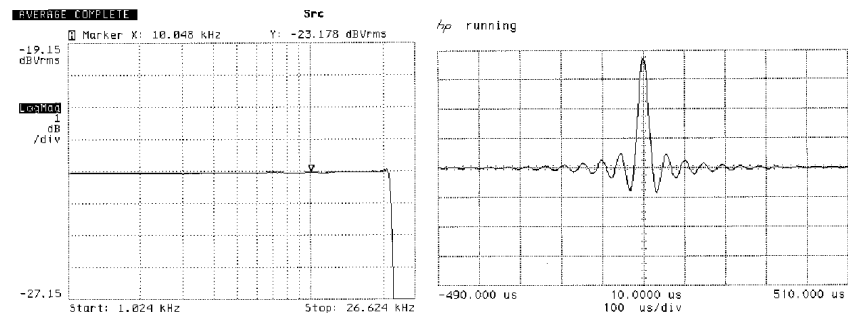

Frequency response and transient characteristics of the long FIR filter

FIR short (Impulse optimised filter)

Shortening the filter (lower coefficient) reduces the time range errors, albeit combined with a slight loss of linearity in the frequency range and damping performance.

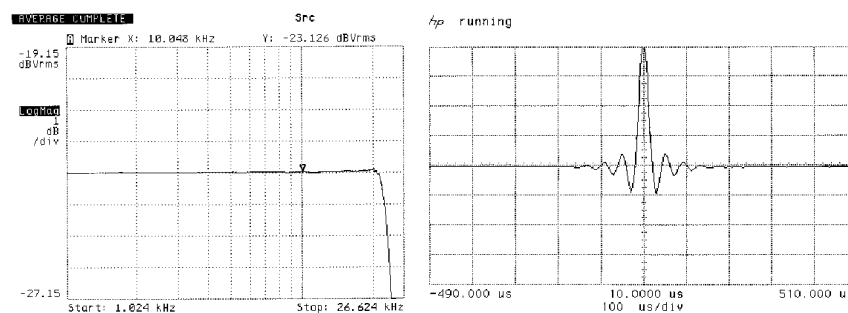

Frequency response and transient characteristics of the short FIR filter

Bezier / IIR (Bezier-interpolator plus IIR-filter)

In this process an ideal Bezier interpolator is combined with what is known as an IIR filter. This eliminates the problematic pre-echo of the FIR method. This process produces highly „analogueue“ system characteristics, with a sound quality and measured performance similar to those of good analogueue record players.

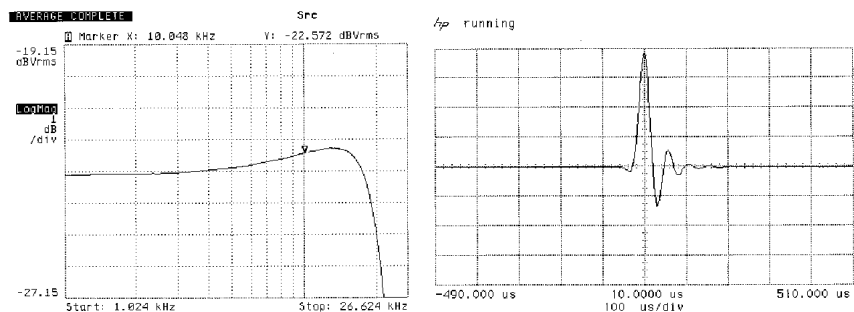

Frequency response and transient characteristics of the Bezier interpolator plus IIR filter

Bezier (pure Bezier interpolator)

This process delivers a perfect reconstruction of the original music signal. It exhibits no pre- or post-echoes of any kind, and does not add coloration or timing errors to the original signal. In sonic terms this method offers an impressive blend of naturalness, good dynamics and accuracy.

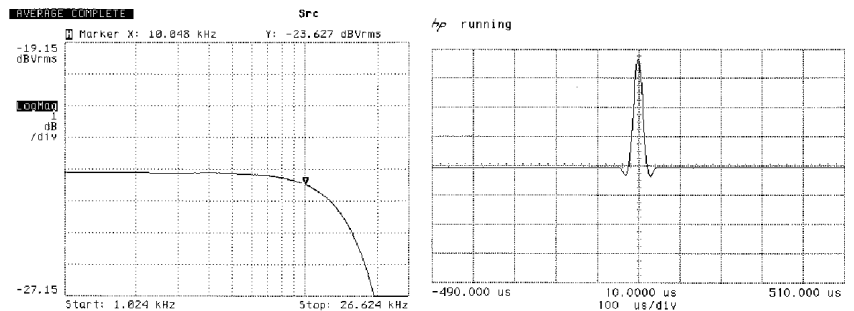

Frequency response and transient characteristics of the Bezier interpolator

Frequency bandwidth of the analogueue reconstruction filter

Normal operation up to 60 kHz and 'Wide'-Mode up to 120 kHz
The 'WIDE' setting produces the best sound quality, but only with high-quality amplifiers which are able to process signal frequencies up to 300 kHz without generating distortion.

If you are in any doubt about the ability of your amplifier to deal with very high signal frequencies up to 300 kHz, please check this with the manufacturer of your equipment.

Alternatively you can set the switch to the WIDE setting, and simply listen to the results. If you hear no interference, and if the sound image is better than that in the NORMAL setting, leave in the WIDE mode.

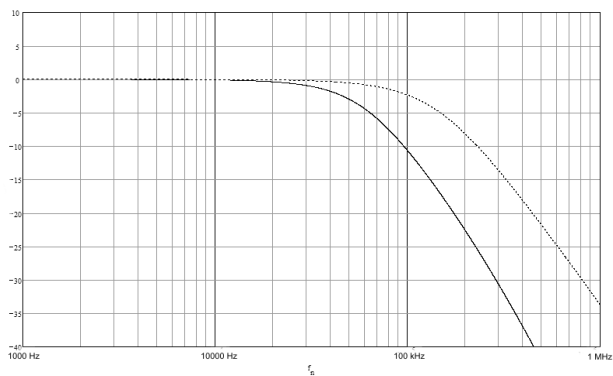

Frequency bandwidth of the two settings

 The 'WIDE' setting can be used without restriction with all **T+A** amplifiers

Network Terminology

General information

The Switch ensures that the individual components within a network are connected correctly. This is only possible if it can identify each device within the network unambiguously; this is the reason why every component is assigned a form of "house number" (IP address). The IP address consists of four number blocks each containing three digits separated by dots (e.g. 192.168.1.1).

Each of the individual number blocks may contain values between 1 and 254 (the values 0 and 255 are reserved for certain special functions, and should therefore not be used). However, if the network is to operate reliably, the network owner should only select addresses designed for home network use - i.e.: the first two number blocks should always be 192.168.xxx.xxx; the third block can be selected without restriction within the above limits (but should be the same for all devices on the network), and the fourth block must distinguish each device uniquely (e.g.: **MP 3000 HV** 192.168.001.001, **NAS**: 192.186.001.002, **PC**: 192.168.001.003, ...).

If this local network is to include Internet music sources (Internet radio) as well as physical devices, then the **T+A MP 3000 HV** must have access to the Internet. This facility is provided by a device such as a router with connection to the DSL network. This router is also a constituent part of the network, and is assigned its own IP address. The **T+A MP 3000 HV** must also be informed of the address of the router (Gateway) to enable it to gain access to the outside world.



Please ensure that the first three blocks of the Device IP, Gateway IP and DNS 1 share the same address space (e.g. 192.168.0.xxx). The fourth block assigns a unique address (house number) to the components in the local network. This number must not be present more than once in the local network. The Device IP mask should always be assigned the address 255.255.255.0.

DNS

The Domain Name System (DNS) is one of the most important services on the Internet. Its primary task is to convert "Internet addresses", such as www.taelektroakustik.de, into the associated IP address. In most home networks the router carries out the DNS function.

If you decide to configure your network manually (without DHCP), then simply enter the address of your router as the DNS address when configuring the network.

Ethernet-LAN

Wired network. Interference-free network technology, with the drawback of having to deploy a network cable.

Gateway

The computer or router in your network which is responsible for managing data traffic between your home network and the outside world (i.e. the Internet).

Client

Network device which obtains data from the network, decodes it and converts it into, for example, analogue music signals which can then be reproduced via an amplifier and loudspeakers. Streaming Clients also contain functions for displaying media content, and for navigating on the Internet or servers.

DHCP

DHCP is an abbreviation of **D**ynamic **H**ost **C**onfiguration **P**rotocol. The primary purpose of DHCP is to enable Clients to obtain your network configuration automatically from a server or router.

IP-Adress

Network address. Each device in the network requires an IP address at which it can be accessed, and by which it is unambiguously identifiable. No individual network address may be present more than once. This is important if you are entering network addresses manually. If the addresses in your network are assigned by DHCP, you do not need to worry about IP addresses at all, as the DHCP server manages the addresses automatically without your intervention.

NAS (Network Attached Storage)	Network storage facility. This is generally a very large-capacity (> 200 GB) storage device to which other devices have access. If the NAS server includes a UPnP-AV server service, then the MP 3000 HV has access to media files stored on the NAS, and can play them back.
Powerline-LAN	In a Power-Line LAN data is transferred via the existing mains power cabling. Devices known as "Power-Line modems" are required at the transmitting and receiving end. In most cases Power-Line offers relatively problem-free data transfer with adequate data rates for audio streaming. We recommend Power-Line modems with bit rates of 85 or 200 Mbit/s.
Proxy server	A Proxy or Proxy server is a computer in the network which is capable of carrying out data transfers faster and more efficiently, and can increase security through the use of access control mechanisms. Most home networks do not include a proxy server. In this case there is no need to enter a Proxy address when configuring the MP 3000 HV network.
Router	Central network device which creates and manages the connections between the network devices. In most networks the router also assumes the function of Gateway to the outside world.
Server	Network device which provides data and services for other devices in the network. For example, a UPnP-AV server typically stores audio / video data, and makes it available to other devices (the Streaming Clients). Many UPnP-AV servers also offer functions such as cataloguing, and easy identification of media content using criteria such as artiste, album name, genre, etc.
UPnP-AV	Network protocol that makes media files available on the home network. On PCs and NAS storage devices a UPnP-AV server software must be installed to enable the MP 3000 HV to access media files stored on these devices. Examples for UPnP-AV server software compatible with the MP 3000 HV : <u>Windows:</u> <ul style="list-style-type: none"> • Twonky Media Server http://www.twonkyvision.de/ • Windows Media Player 11 http://www.microsoft.com/windows/windowsmedia/de/default.aspx <u>Linux:</u> <ul style="list-style-type: none"> • Mediatomb http://mediatomb.cc/ • GmediaServer http://www.gnu.org/software/gmediaserver/
WLAN (also W-LAN, Wireless LAN)	Radio network. The network is connected by means of radio waves operating in the 2.4 GHz frequency band. Radio networks are easy to install as no cables have to be deployed, but they are often problematic and unreliable - especially when the transmission distances are substantial. Power-Line networks, which can also be installed without separate cabling, are a better choice in many situations. In every case the deployment of a network cable is the most reliable and problem-free technology for data transfer.
Compatible hardware and UPnP servers	The marketplace offers a vast number of routers, NAS devices and USB hard discs made by a very wide range of manufacturers. T+A equipment is generally compatible with other makes of machine which bear the UPnP label. A list of devices which T+A has checked for compatibility can be found on the Internet at: http://www.taelektroakustik.de/hardware/comp_lan_hw.pdf .

Trouble shooting

Many problems have a simple cause and a correspondingly simple solution. The following section describes a few difficulties you may encounter, and the measures you need to take to cure them. If you find it impossible to solve a problem with the help of these notes please disconnect the unit from the mains and ask your authorised **T+A** specialist dealer for advice.

Machine does not switch on (Display does not light up).

Cause 1:
Mains leads not plugged in correctly.
Remedy:
Check connection, push connector in firmly.

Tuner

Whistling or whispering noises from the speakers.

Cause:
The antenna lead is routed too close to a mains, remote control or audio signal cable.
Remedy:
Move the leads so that they are spaced well apart. Use the domestic (loft or outside) antenna or a cable connection.

The RDS station name does not appear in the display.

Cause 1:
The station is not broadcasting **RDS** information.
Cause 2:
Reception is poor, interference is severe, or the *field strength* (signal strength) is low.
Remedy:
Select only those stations which can be received with a strong signal: hiss-free and without interference.

The unit can be operated normally, but very few stations or none at all can be picked up.

Cause:
The antenna system or antenna cable is faulty.
Remedy:
Check the antenna lead for good contact at the antenna socket (at the wall) and in the back of the tuner. As a test, try using the system with a trailing antenna. If you can now receive stations reasonably well, we recommend that you call out an expert antenna technician to check your antenna system.

CD player

The screen displays the message 'No Disc' when you close the CD drawer.

Cause 1:
CD not inserted correctly.

Remedy:
Place CD centrally in the drawer, printed face up.

Cause 2:
CD dirty.

Remedy:
Clean disc and insert again.

Cause 3:
CD damaged in the Table of Contents (TOC) area.

Remedy:
No remedy; the CD is unusable.

Cause 4:
The CD player has become very cold (e. g. in transit) and condensation has formed on the laser sensor optics.

Remedy:
Allow the unit to warm up for about an hour in a warm, well ventilated location.

CD playback stops or 'jumps'.

Cause 1:
CD damaged or dirty.

Remedy:
Clean CD. A damaged CD cannot be repaired!

Cause 2:
The CD uses a copy protection system which does not conform to the CD-Audio standard (Red Book Standard)

Remedy:
Take back the CD to the dealer and ask for a proper CD according to the general CD standard.

Loud humming noise from the loudspeakers.

Cause:
Poor contact between the Cinch plugs and sockets, or a faulty Cinch cable.

Remedy:
Please check all connections and cables thoroughly.

Streaming Client

The streaming client cannot connect to a network.

On the display the indication 'SCL Connecting...' is displayed.

Cause 1 (cable LAN):

Network cable not properly connected

Remedy:

Connect network cable, check connection to router

Cause 2 (wireless LAN):

WLAN antenna not connected or placed in a location with bad reception quality

Remedy:

Connect WLAN antenna properly and find a location with good reception quality.

Set the transmission power output of your WLAN router to maximum.

Try to establish a network connection first in a location close to the WLAN router. If this succeeded try to connect to WLAN from a more remote location. Experiment with antenna position and try to find a location with better reception quality.

Cause 3 (wireless LAN):

WLAN reception quality bad (low field strength). Possibly too much attenuated by walls/ceilings on the transmission path.

Remedy:

Optimize location of receiver and transmitter antennas.

Alternative:

If transmission problems persist a so called 'Power Line' network might be good alternative to establish a good and stable network connection.

The best, safest and most secure network however will always be a cable LAN network.

Cause 4:

Network parameters not properly configured.

Remedy:

Configure the network parameters correctly (see chapter '**Network configuration**').

Cause 5 (operation without network connection):

For proper operation the **MP 3000 HV** needs at least one properly connected network device. This can be a LAN or WLAN network or a USB storage device.

Remedy:

If the **MP 3000 HV** shall be operated without network (LAN / WLAN) please connect at least a USB stick.

The message

'Track not found' is displayed

Cause:

The music file on the storage device or on the music server was deleted or the internet radio station is not available at the moment.

Remedy:

Choose another music title or radio station. If the station or title is not available any more it should be deleted from the Favourites List (if stored there).

The message

'Format Error' is displayed

Cause:

The title is stored / the radio station is transmitting in a format that cannot be decoded by the **MP 3000 HV**.

Remedy:

Choose another title or station.

The message

'network problems – restarting' is displayed

Cause:

Network problems in your home network or on the internet occurred; the connection was interrupted.

Remedy:

When encountering a network problem or interruption the **MP 3000 HV** will re-start the network communication. After re-start please choose a music title or internet radio station and start playback.

<p>Transmission interruptions occur when listening to internet radio stations.</p>	<p>Cause 1: The capacity of the internet radio station's server is at its limit.</p> <p>Remedy: Choose a different station.</p>
	<p>Cause 2: Network problems occurred.</p> <p>Remedy: Check your network (see above).</p>
<p>Some internet radio stations cannot be received</p>	<p>Cause: The internet radio station has been switched off, it transmits only at certain hours of the day or it has changed its internet address.</p> <p>Remedy: Try to get information from the website of the station regarding transmission hours and internet address (URL). Try to establish a connection to the station at a later time.</p>
<p>Bad sound quality at certain internet radio stations</p>	<p>Cause: The station transmits with a low audio bandwidth (low bitrate).</p> <p>Remedy: Use stations transmitting at least at 128 kBit/s. This is the lowest recommended bitrate for adequate sound quality. For good sound quality we recommend high bitrates like 320 kBit/s</p>
<p>USB Storage device is not recognised</p>	<p>Cause 1: The storage device (especially USB hard discs without separate power supply) draws more electrical current from the USB interface than is permitted by the USB standard.</p> <p>Remedy: Only use USB storage devices that conform to the USB standard or use storage devices with own power supplies.</p> <p>Cause 2: The storage device is not formatted with an appropriate file system.</p> <p>Remedy: The MP 3000 HV accepts storage devices with FAT16 or FAT32 file systems.</p> <p>Note: For big music archives we recommend to use a NAS (network attached storage) device with a UPnP-AV server to which the MP 3000 HV will connect via your home network.</p>
<p>Problems occur with high-resolution audio formats (HD audio) (FLAC and WAV).</p>	<p>Cause: The MP 3000 HV is receiving audio data via a WLAN connection. WLAN connections do not provide reliable quality, and in most cases are not adequate for HD audio.</p> <p>Remedy: If you want to play back HD audio formats via a network connection, please use a LAN cable network.</p>

Appendix

Appendix A

Wiring diagram

PA 3000 HV

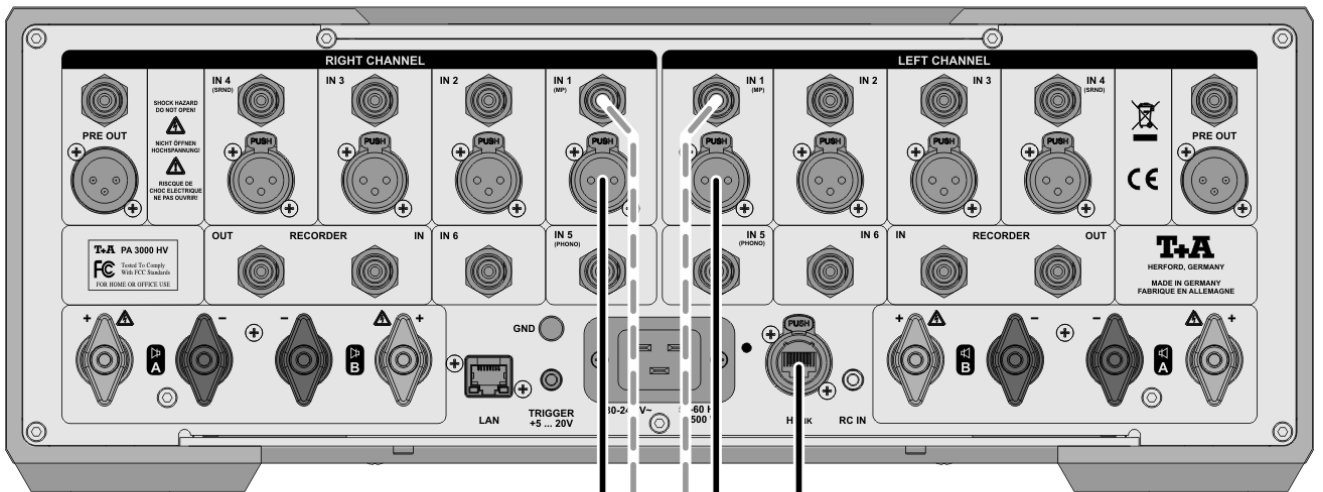

*1

MP 3000 HV

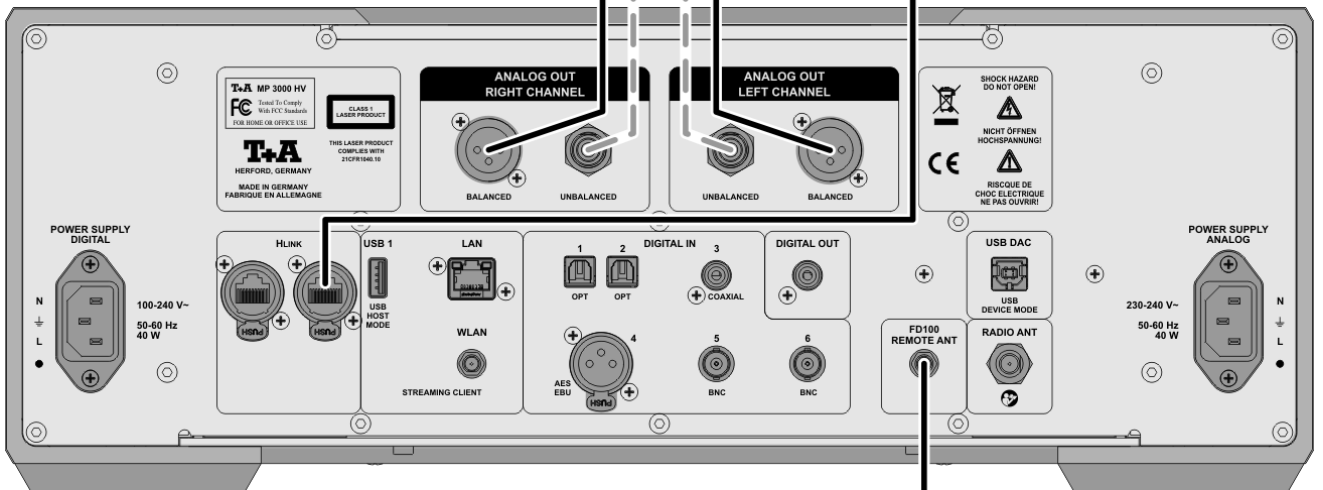

*2

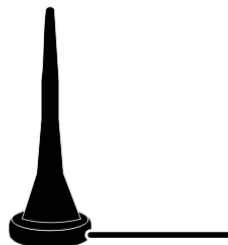

*1 If both types of connection are present on the amplifier, we recommend the symmetrical option

*2 Antenna for the RF remote control FD100. Connecting this antenna is absolutely necessary for operation of the MP 3000 HV by the FD100 remote control.

Wiring diagram

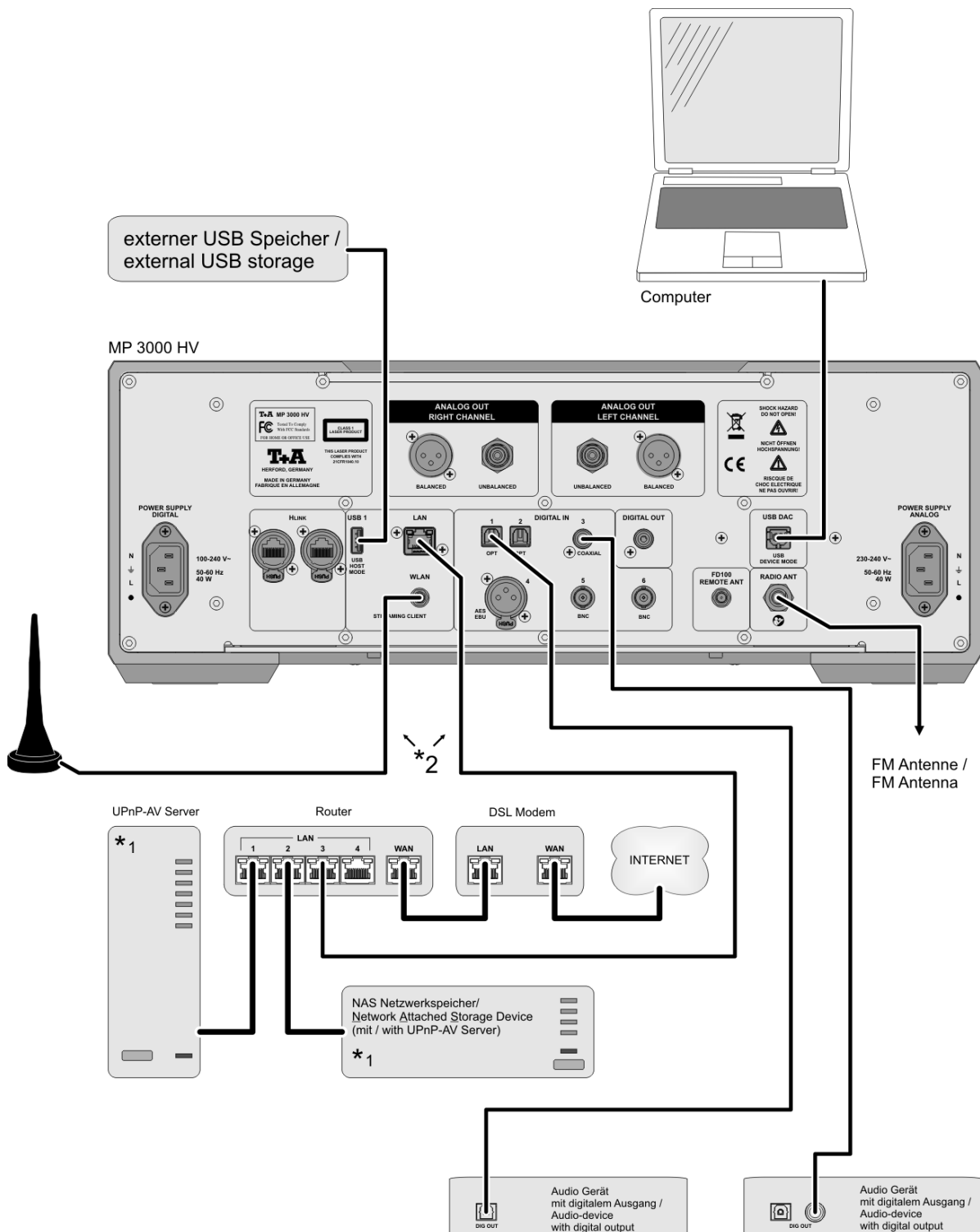

Attention!

A properly set up home network with router must be installed and in operation to use the **MP 3000 HV**.

For the use of internet radio a DSL access to the internet is needed.

For questions regarding setting up your network and internet connection please ask your system administrator or any network specialist.

*1 Music Server with UPnP-AV server software installed

*2 Connection either via Cable-LAN or Wireless-LAN

Wiring diagram

PA 3000 HV

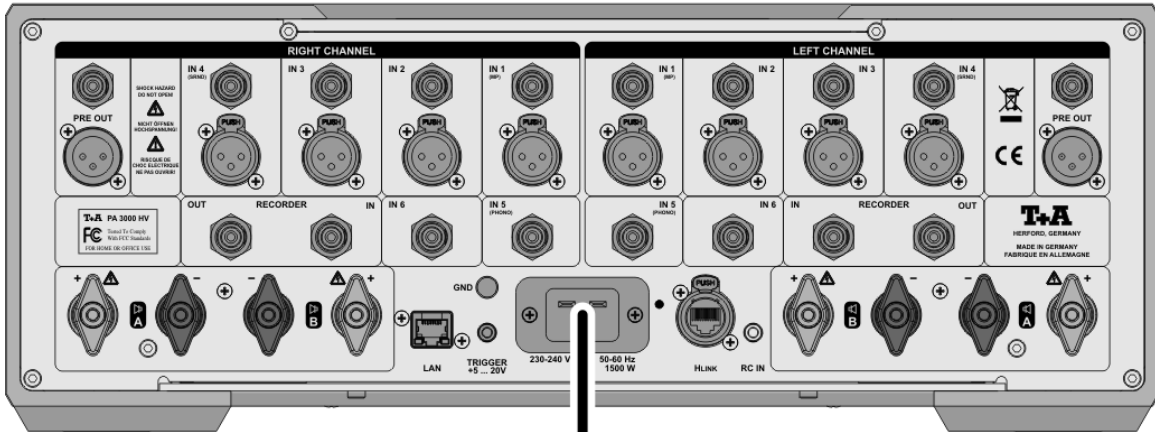

MP 3000 HV

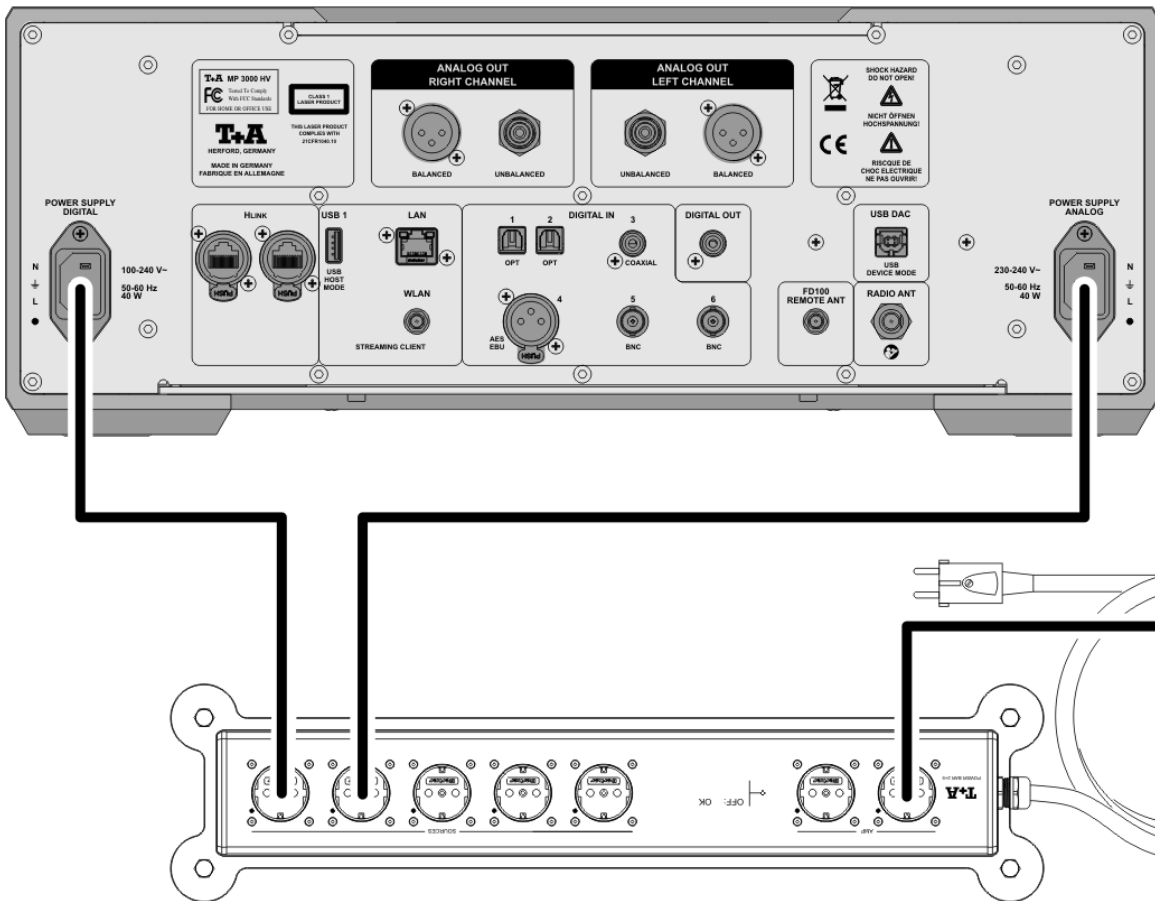

Appendix B

Specification

CD-Player

Formats	CD/DA, CD-R, CD-RW, CD-Text
Frequency response and dynamic	2 Hz – 20 kHz / 100 dB

Streaming Client

Formats	MP3, WMA, AAC, FLAC, OGG-Vorbis, FLAC (192 / 32 over LAN) and WAV (192 / 32 over LAN), AIFF (192 / 32 over LAN), ALAC (96/24 over LAN)
---------	--

Supported Media server

	UPnP 1.1, UPnP-AV and DLNA compatible Server, Microsoft Windows Media Connect Server (WMDRM10), vTuner Internet Radio Service, DLNA compatible Server
--	---

Features

	Auto Network Config., Internet Radio Station database (automatic updates)
--	---

Tuner

	FM Radio 87,5 – 108 MHz
Sensitivity	1,3 μ V
Overload margin	>125 dB μ V,
Cross talk damping	> 40dB
RDS Functions	Station name, Radiotext

Connections

Analogue outputs	
asymmetric co-axial (RCA)	2,5 V _{eff} / 50 Ohm
symmetric (XLR)	5,0 V _{eff} / 50 Ohm
Output digital	1x co-ax, IEC 60958 (LPCM)
Digital inputs	1x AES-EBU 192/24, 5x S/P-DIF: 2 high quality BNC 192/24, 1x standard co-ax (RCA) and 2 optical TOS-Link mit 96/24. 1x USB Device-Mode - USB Class 1 (up to 96/24) or USB Class 2 (up to 192/24), supports asynchronous (USB 2 mode) or synchronous (USB 1 Mode) data transfer. 2x USB master-mode for USB-mass storage devices (USB stick or VFAT formatted harddisc)

D/A-Converter

	Double-Differential-Quadruple-Converter with 4 D/A converters per channel, 32-Bit Sigma Delta, 352,8 kSps / 384 kSps.	
Upsampling	Programmable Digital Signal Processor with 4 selectable oversampling algorithms: FIR short, FIR long, Bezier/IIR, Bezier	
Analogue filter	Phase-linear Bessel filter 3 rd order, switchable 60 kHz or 120 kHz	
Frequency response	2 Hz - 20 kHz	44.1 kSps
	2 Hz - 22 kHz	48.0 kSps
	2 Hz - 40 kHz	96.0 kSps
	2 Hz - 80 kHz	192.0 kSps
Total harm. distortion	< 0.001 %	
Signal : noise ratio, A-weighted:	116 dB	
Channel separation	110 dB	

Power requirement

230 V version 1x 220 - 240 V~ and 1x 100 - 240 V~ , 50-60 Hz

115 V version 1x 110 - 115 V~ and 1x 100 - 240 V~ , 50-60 Hz

Power consumption max. 2x 40 W
Standby < 0,5 W

Dimensions and weight

H x W x D [cm] 17 x 46 x 46

26 kg

Accessory

User manual, H-Link cable, Radio remote control FD100, W-LAN aerial, FD100 aerial, charger for FD100, BNC to RCA adaptor, FM aerial, USB cable, 2x power cord, RCA cable.

We reserve the right to alter specifications.

T+A elektroakustik GmbH & Co. KG

Herford

Deutschland * Germany