



USER MANUAL

R-SERIES

MP 2000 R

Welcome.

We are delighted that you have decided to purchase a **T+A** product. With your new **MP 2000 R** you have acquired a top-quality piece of equipment which has been designed and developed with the wishes of the audiophile music lover as absolute top priority.

This system represents our very best efforts at designing practical electronic equipment incorporating solid quality, user-friendly operation and a specification and performance which leaves nothing to be desired.

All these factors contribute to a piece of equipment which will satisfy your highest demands and your most searching requirements for a period of many years. All the components we use meet the German and European safety norms and standards which are currently valid. All the materials we use are subject to painstaking quality monitoring.

At all stages of production we avoid the use of substances which are environmentally unsound or potentially hazardous to health, such as chlorine-based cleaning agents and CFCs.

We also aim to avoid the use of plastics in general, and PVC in particular, in the design of our products. Instead we rely upon metals and other non-hazardous materials; metal components are ideal for recycling, and also provide effective electrical screening.

Our robust all-metal cases exclude any possibility of external sources of interference affecting the quality of reproduction. From the opposite point of view our products' electro-magnetic radiation (electro-smog) is reduced to an absolute minimum by the outstandingly effective screening provided by the metal case.

The case of the **MP 2000 R** is built exclusively from the finest-quality non-magnetic metals of the highest purity. This excludes the possibility of interaction with the audio signals, and guarantees uncoloured reproduction.

We would like to take this opportunity to thank you for the faith you have shown in our company by purchasing this product, and wish you many hours of enjoyment and sheer listening pleasure with your **MP 2000 R**.

T+A elektroakustik GmbH & Co KG



All the components we use meet the European safety norms and standards which are currently valid. The operation instructions, the connection guidance and the safety notes are for your own good - please read them carefully and observe them at all times.

This product complies with the Low Voltage Directive (73/23/EEC), EMV Directives (89/336/EEC, 92/31/EEC) and CE Marking Directive (93/68/EEC).

IMPORTANT! CAUTION!

This product contains a laser diode of higher class than 1. To ensure continued safety, do not remove any covers or attempt to gain access to the inside of the product.

Refer all servicing to qualified personnel.

The following caution label appears on your device:

Rear Panel:

CLASS 1
LASER PRODUCT

On the inner protective housing of the CD mechanism

| | |
|-------------------|---|
| CAUTION: | VISIBLE AND INVISIBLE LASER RADIATION WHEN OPEN. AVOID EXPOSURE TO BEAM |
| VORSICHT: | SICHTBARE UND UNSICHTBARE LASERSTRAHLUNG, WENN ABDECKUNG GEÖFFNET NICHT DEM STRAHL AUSSETZEN |
| ATTENTION: | RAYONNEMENT LASER VISIBLE ET INVISIBLE EN CAS D'OUVERTURE EXPOSITION DANGEREUSE AU FAISCEAU |
| DANGER: | VISIBLE AND INVISIBLE LASER RADIATION WHEN OPEN. AVOID DIRECT EXPOSURE TO BEAM |

Contents

| | Page |
|--|------|
| Introduction | |
| PCM and DSD | 5 |
| Operation | |
| Front panel controls | 6 |
| Remote Control | 10 |
| Selecting sources in an integrated system | 13 |
| Basic settings of the MP 2000 R (System Configuration menu) | 14 |
| D/A Converter Settings | 17 |
| Operating the source devices in detail | 18 |
| Operating the Radio | 19 |
| Operating the CD player | 23 |
| Playback Program | 25 |
| Operating the Streaming Client | 26 |
| Access to Media Content via the Main Menu (Home Menu) | 29 |
| Accessing Media Content using the Favourites List | 30 |
| Operating the Bluetooth source | 31 |
| The MP 2000 R as D/A Converter | 33 |
| USB-DAC operation in detail | 34 |
| Using the system for the first time | |
| Back panel connections | 36 |
| Installation and wiring | 38 |
| Safety notes | 40 |
| FCC Information to the user | 41 |
| Network Configuration | 42 |
| The vTuner Premium Service | 48 |
| General | |
| FD 100 Radio Remote Control | 50 |
| Firmwareupdate | 51 |
| Glossary / Supplementary Information | 53 |
| Technical description / Digital filters / Oversampling | 54 |
| Network Terminology | 56 |
| Trouble-shooting | 58 |
| Appendix | |
| Wiring diagram | 62 |
| Specification | 64 |

About these instructions

All the controls and functions of the **MP 2000 R** which are frequently used are described in the first section of these operating instructions.

The second part - '**Basic settings, Installation, Using the system for the first time**' covers connections and settings which are very seldom required; they are generally required only when the machine is set up and used for the first time. Here you will also find a detailed description of the network settings required for connecting the **MP 2000 R** to your home network.

Symbols used in these instructions



Caution!

Text passages marked with this symbol contain important information which must be observed if the machine is to operate safely and without problems.



This symbol marks text passages which provide supplementary notes and background information; they are intended to help the user understand how to get the best out of the machine.

Introduction

PCM and DSD

Two competing formats are available in the form of PCM and DSD, both of which are used to store audio signals at very high resolution and quality. Each of these formats has its own specific advantages. A vast amount has been written about the relative merits of these two formats, and we have no intention of participating in the dispute, much of which is less than objective in nature. Instead we consider it our task to develop equipment which reproduces both formats as effectively as possible, and exploits the strengths of each system to the full.

Our many years of experience with both systems have clearly shown that PCM and DSD cannot just be lumped together; it is essential to treat each format separately, and take their specific requirements into account. This applies both at the digital and analogue level.

For this reason the **MP 2000 R** employs two separate digital sections and two D/A converter sections - each optimised for one format.

MP 2000 R and DSD

By its nature the DSD format involves a noise floor which rises above the range of human hearing as frequency rises. Although this noise floor is not directly audible, it does subject the treble units in the loudspeakers to a significant load. It is also possible for the high-frequency noise to cause distortion in many low-bandwidth amplifiers.

The lower the DSD sampling rate, the more severe the inherent noise, and it cannot be disregarded, especially with the DSD64 format - as used on the SACD. As the DSD sampling rate rises, the high-frequency noise becomes increasingly insignificant, and with DSD256 it is virtually irrelevant. In the past it has been standard practice to apply digital and analogue filtering processes in an attempt to reduce DSD noise, but such solutions are never entirely without side-effects on sound quality. For the **MP 2000 R** we have developed two special techniques designed to eliminate the sonic disadvantages:

- 1.) The **T+A** True-DSD technique, consisting of a direct digital signal path without filtering and noise-shaping, plus our True 1-bit DSD D/A converter
- 2.) Analogue reconstruction filter with automatic bandwidth selection.

MP 2000 R and PCM

The PCM process makes extremely high-resolution sampling values available: up to 32 bits. However, the sampling rate of PCM is significantly lower than that of DSD, and the spacing in terms of time between the sampling values is greater.

This means that it is extremely important with PCM to employ maximum possible precision when converting the high resolution into analogue signals. Here at **T+A** our answer was to develop quadruple D/A converters which provide a four-fold improvement in accuracy over conventional converters. A further very important aspect of PCM reproduction is to reconstruct the curve of the original analogue signal between the sampling points with great accuracy, since these points are much more widely spaced in comparison with DSD. To this end the **MP 2000 R** employs a polynomial interpolation process (Bezier-Spline interpolation) developed in-house at **T+A**, which in mathematical terms delivers the smoothest curve for a given number of reference points (sampling points). The output signal generated by Bezier interpolation exhibits a very "natural" shape, devoid of the digital artefacts - such as pre- and post-oscillation - which are usually produced by the standard oversampling process. More detailed information on this can be found in the chapter "**Technical description, oversampling / up-sampling**"

Front panel controls

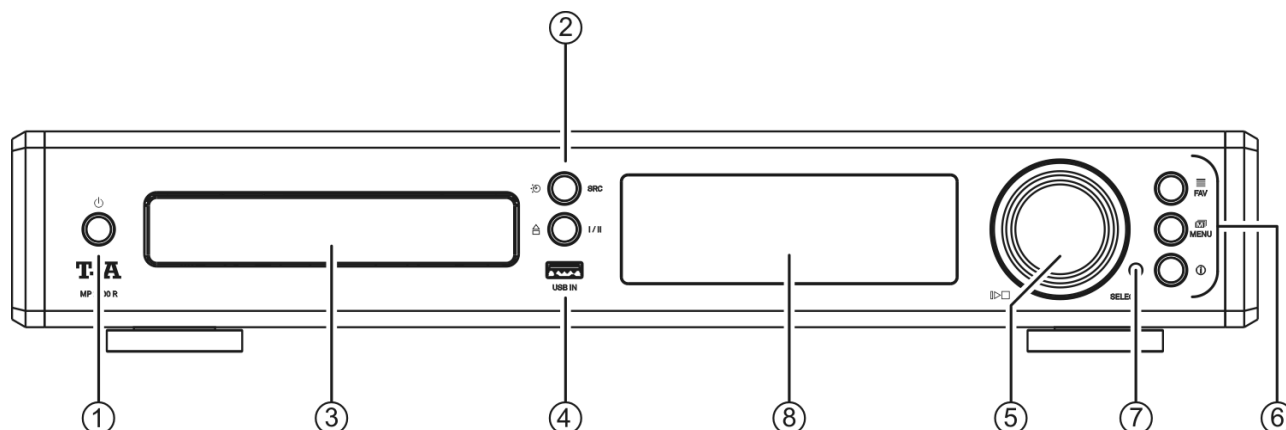

All the important functions of the **MP 2000 R** can be controlled using the buttons and the rotary knob on the front panel. Direct-acting buttons are provided for fundamental functions such as source select. Functions which are needed less frequently are controlled using a menu which is called up by pressing the **MENU** button.

All information relating to the machine's state, the current track and the associated transmitting station are displayed on the integral screen. The following section explains the functions of the buttons on the machine, and the information provided on the screen.

① On / Off switch



A brief press on the  button switches the unit on and off.



In **Comfort Standby** mode the  button of the **MP 2000 R** glows dimly to indicate its state of readiness. In **Eco Standby** mode the  button is not lit. (see chapter 'Basic settings of the MP 2000 R')



Caution!

The mains button is not an isolation switch. Certain parts of the machine remain connected to mains voltage even when the screen is switched off and dark. If you know you will not be using the machine for a long period, we recommend that you disconnect it from the mains by withdrawing the mains plugs from the wall socket.

② Source selection





SRC

Pressing this button selects the desired listening source. Press the button repeatedly until the desired listening source appears on the screen.

③ CD drawer

The drawer is opened and closed by pressing the  button.

If you press the  /  button after placing the CD in the machine, the drawer closes and playback starts with the first track. The open drawer also closes if you enter the number of a track using the remote control handset.

④ Front USB socket (USB 2)

Socket for a USB memory stick or an external hard disc.

The storage medium must be formatted with the FAT16 or FAT32 file system.

The USB storage medium can be powered via the USB socket provided that its current drain meets the USB norm (< 500 mA). Normalised 2.5" USB hard discs can be connected directly to this socket, i.e. they require no mains PSU.

⑤ Navigation / Control

SELECT knob



Rotating this control selects a track for playback; the selected track then appears on the screen. As soon as the desired track number lights up, the track can be started by pressing the incremental control.



As well as selecting tracks, the incremental encoder is used for functions such as navigating within lists, controlling menus, and creating playback programs. (see chapter '**Basic settings of the MP 2000 R**')

⑥ Operating buttons



Brief press: displays the Favourites list stored on the **MP 2000 R**

(see chapter '**Operating the radio, Favourites list**' and '**Operating the Streaming Client, accessing media content via the Favourites list**')

In the list a Favourite can be selected using the SELECT knob; a brief press on the same knob then plays it.

Closing the list

A long press on the SELECT knob closes the Favourites list without switching to a Favourite.



Brief press: Opens the '**System Configuration**' menu (see chapter '**Basic settings of the MP 2000 R**')

Long press: Opens the **Source Configuration menu**.



Brief press: Toggle switch between display of current music track and list navigation / switches the CD Text on and off.

Long press: Switches between different screen displays

⑦ Fernbedienungsempfänger



When using the remote control system please point the **FM2000** handset in the direction of the receiver.

The line of sight between the **FM2000** and the remote control receiver in the **FM2000** must not be interrupted by any obstacles. Installing the **FM2000** behind the glass doors of a cabinet will also adversely affect the remote control system. It is essential to prevent potentially interfering light (from fluorescent lamps and energy-saving bulbs) falling directly on the receiver, as this may markedly reduce the effective range of the remote control system.

⑧ Display

The graphic screen of the **MP 2000 R** displays all information regarding the status of the machine, the music track currently being played and the radio station currently tuned. The display is context-sensitive and varies according to the capabilities and facilities of the service or medium to which you are currently listening.

The most important information is highlighted on the screen in a context-sensitive manner. Supplementary information is displayed above and below the main text, or by means of symbols. The symbols used are listed and explained in the table below.

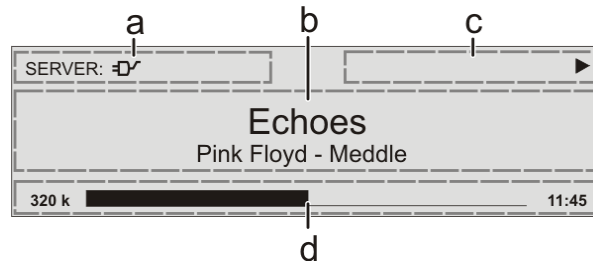

z.B.

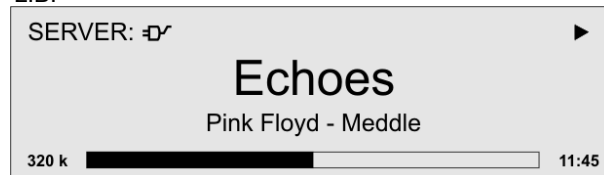

The displays and symbols which appear on the screen vary according to the currently active function.

The basic areas of the screen:



















- Display field (a) shows the currently active source.
- Display field (b) shows information relating to the piece of music being played. The essential information is displayed enlarged in the main line.
- Display field (c) shows information relating to the device and playback.
- The bottom line (d) displays supplementary context-sensitive information (e.g. sampling frequency, elapsed time)

i The **MP 2000 R** provides different screen displays for the Streaming Client and the radio.

- **Large-format display:**
Enlarged display of the most important information, clearly legible even from a distance
- **Detail display:**
Small-text display showing a large number of additional information points, e.g. bit-rate etc.

A long press on the  button on the remote control handset is used to switch between the display modes.

Screen symbols and their meaning

| | |
|--|--|
|  | Making connection (Wait / Busy) The rotating symbol indicates that the MP 2000 R is currently processing a command, or is attempting to connect to a service. These processes may take some time to complete depending on the speed of your network and the load upon it. During such periods the MP 2000 R may be muted, and may not respond to the controls. Please wait until the symbol disappears, then try again. |
|  | Indicates a music track which can be played , or a playlist . |
|  | Indicates a folder which conceals further folders or lists. |
|  | Indicates that a source is being reproduced via a cable connection . |
|  | Indicates that a source is being reproduced via a radio connection . |
|  | Indicates that the MP 2000 R is reproducing a station or playing back a music track. |
|  | Pause indicator |
|  1 or  2 | Indicates the selected USB socket. |
|  | Indicates that the speakers A and B are switched off. (in 2-zone mode only if speakers A are switched off) |
| 128 k   | Buffer display (fullness indicator, memory display) and data rate indicator (if available): The higher the data rate, the better the quality of reproduction. |
|  1:20 | Display of the elapsed playback time. This information is not available for all services. |
|  | Indicates that the  button can be used to switch to a higher menu or select level. |
| 0 / 0 | Position indicator in select lists. The first number shows the current position in the list, the second number the total number of list entries (length of list). |
|  | Indicates that the selected menu item or list point can be activated by pressing the  button. |
| ABC or 123 or abc | Display of the symbol input modes |
|   | Indicates the field strength of the radio signal. |

Remote control

General Information





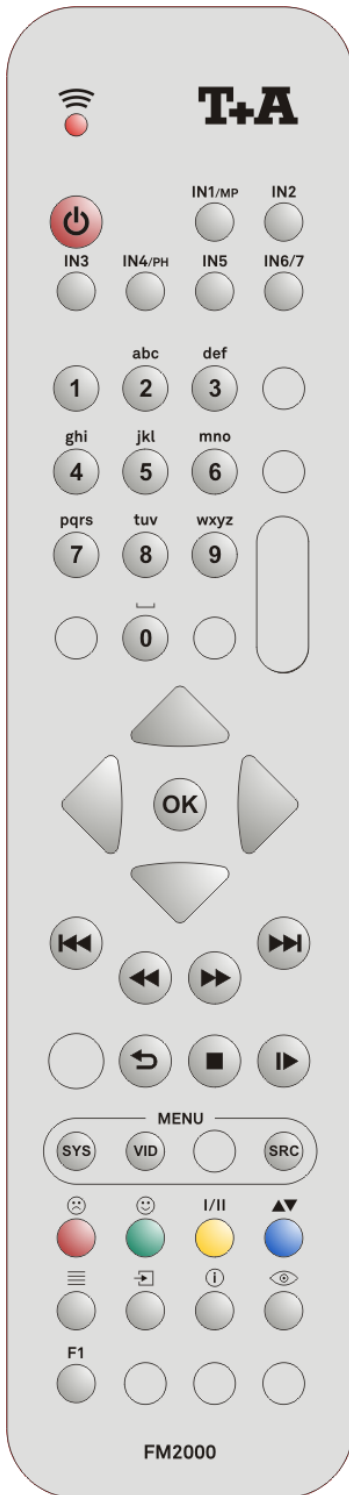







In general terms the remote control buttons have the same function as the corresponding buttons on the **MP 2000 R**'s front panel.













i The buttons not required to operate the **MP 2000 R** are not shown in the illustration of the **FM2000**.



| | |
|-------------------------------------|--|
| | Switches the MP 2000 R on and off |
| Direct source select buttons | |
| | <p>If the MP 2000 R is operated in “stand alone” mode, sources are selected using this procedure:</p> <p> selects the Streaming Client function</p> <p> selects the CD player function</p> <p> A brief press on this button selects the digital input you wish to use. Press the button repeatedly until the desired input is displayed on the screen.</p> <p> selects the USB DAC Input as source</p> <p> A brief press on this button selects the radio function you wish to use. Press the button twice to switch between FM and DAB radio.</p> <p> selects the Bluetooth source</p> <p> (For operation in a system with a PA) When used within a system which includes a PA 2x00 R connected using R2Link, a brief press of the button switches to the MP 2000 R as listening source. Further brief presses on this button cycle through the sources of the MP 2000 R. Alternatively a long press of the button opens a Source Select menu in which you can select the desired source of the MP 2000 R using the navigation buttons.</p> |
| ... | |
| | |
| | |
| | |
| | |
| Navigation | |
| | Returns to the previous point / change button |
| | Confirms the input / change button |
| | Selects the previous point within a list / select button |
| | Selects the next point within a list / select button |
| | Confirmation button during input procedures |
| Alpha-numeric input | |
| | <p>Direct alpha-numeric input, e.g. track number, fast station select, radio station.</p> <p>The and buttons are also used for non-standard characters.</p> <p> During text input you can switch between numeric and alpha-numeric input, and between capitals and lower case by pressing the button.</p> |
| | |
| abc | |
| ... | |
| | |
| | <p>Starts playback (Play function)</p> <p>During playback: halts (Pause) or resumes playback</p> |
| | |
| | Stops playback |
| | Opens the system configuration menu |
| | Opens the D/A converter settings menu |
| | <p>During character input:</p> <p>Switches between numeric and alpha-numeric input, and between capitals and lower case when pressed (repeatedly)</p> <p>In lists: Search function (Alpha search)</p> |
| | Repeated brief presses cycle through the various display modes |

i The **FD 100**, a graphic radio remote control handset with integral colour screen, is designed to make the **MP 2000 R** even more convenient to operate, and is available as part of the **T+A** accessory range.

| | Tuner | CD-Player | Streaming Client |
|---|---|---|---|
| | Navigation | | Navigation |
|  | Back to previous point During alpha-numeric character input you can erase a character with the  button. | | Back to previous point |
|  | Confirms input | | - Opens a folder - Starts a piece of music - Selects an Internet radio station |
|  | Selects the previous point within a list | | Selects the previous point within a list |
|  | Selects the next point within a list | | Selects the next point within a list |
|  | Confirm buttons during input process | | |
| | Chapter select / Track select / Search / Manual tuning | | |
|  | | Selects the previous track during playback | Selects the previous piece in the playback list |
|  | Brief press: Manual tuning Long press: Search | Rewind to search for a particular passage | Hold button pressed in for rewind |
|  | Brief press: Manual tuning Long press: Search | Fast-forward to search for a particular passage | Hold button pressed in for fast forward |
|  | | Selects the next track during playback | Selects the next piece in the playback list |
|  (REPEAT) | | Repeat function (see Chapter ' <i>Operating the CD player</i> ') | Repeat functions (not possible with all media) Brief press: Repeat Track, Repeat ALL, 'Normal' Long press: Mix-Mode (Shuffle) ON / OFF Brief button presses in MIX mode: Mix, Repeat Track, Repeat Mix |
|  (STOP) | | Brief press: Halts playback Long press: Opens and closes the CD draw in STOP mode | Ends playback |
|  (PLAY/ PAUSE) | Select station from Favourites list | <ul style="list-style-type: none"> • Starts playback (Play function) • During playback: halts (Pause) or resumes playback | <ul style="list-style-type: none"> • Starts playback (Play function) • During playback: halts (Pause) or resumes playback |

| | Tuner | CD-Player | Streaming Client |
|---|--|--|---|
|  | Opens the System Configuration menu (e.g. for adjusting screen brightness) | | |
|  | Opens the Favourites menu when the Favourites list is displayed. | | Brief press: Switches to main menu (Home) Long press: Opens the network configuration menu |
|  | Long press: Removes a favourite from the station list | Long press: Erases <i>playback program</i> | Long press: Removes a favourite from the Favourites list created on the MP 2000 R |
|  | Adds a favourite to the station list | Activates playback programming Adds a <i>track</i> to the <i>playback program</i> during playback programming | Adds a favourite to the Favourites list created on the MP 2000 R |
|  | Button for switching between Stereo and Mono reception The Stereo setting is constantly displayed in the screen window by a  symbol. The Mono setting is constantly displayed in the screen window by a  symbol. | | the main menu is displayed: Toggle switch between inputs USB 1 (Back panel) and USB 2 (Front panel) |
|  | | | During character input: Switches between numeric and alpha-numeric input, and between capitals and lower case when pressed (repeatedly) In lists: Search function (Alpha search) |
|  | Displays the Favourites list | | Displays the Favourites list created on the MP 2000 R |
|  | Store button for fast station select | | Store button for fast station select |
|  | Switches the Radiotext function ON/OFF | Switches CD-Text ON/OFF | Toggles the display between the 'Now Playing' view and track list / station list navigation. |
| A long press toggles between different screen displays. | | | |
|  | Switches between the <i>Digital filter</i> / Invert functions | | |

 The **MP 2000 R** can be controlled by the **T+A** App 'TA Control' too.
For further information please visit our homepage
www.ta-hifi.com

Smartphone



Tablet PC



Selecting sources in an integrated system

MP 2000 R in a system with the PA 2x00

If the **MP 2000 R** is part of a system which includes a **PA 2x00 R**, and is connected via the **R2Link** connection, the **MP 2000 R** sources are selected either by repeatedly pressing the **IN1 / MP** button, or using the source select menu, instead of directly using the FM2000's source select buttons. Since the FM2000 handset controls the whole system, the handset's source select buttons are used to select the **PA 2x00's** sources when it is part of a system.

This is the procedure for selecting the sources of the **MP 2000 R** using the Source Select menu:

- A long press on the FM2000's **IN1 / MP** button calls up the Source Select menu: a pop-up window appears on the screen of the **MP 2000 R** showing the currently active source.
- Your chosen source can be selected using the **▲** / **▼** buttons, then confirmed by pressing the **OK** button.
- The pop-up window closes, and the system plays the source you have selected.

Basic settings of the MP 2000 R

System Settings (System Configuration menu)

In the System Configuration menu general device settings are adjusted. This menu is described in detail in the following chapter.

Calling up and operating the menu

- Briefly press the **MENU** button on the front panel or **SYS** button on the remote control handset to call up the menu.
- When you open the menu, the following Select points appear on the screen:

| Adjustment facility | | | |
|---------------------|---------------|-----------|-----------------------------|
| Sources | Configuration | | |
| Brightness | 1 | ... | 7 |
| Display Mode | Always on | Temporary | Always off |
| Language | Deutsch | English | Francaise further languages |
| Device name | MP 2000 R | | |
| Energy saver | On | Off | |
| FD 100 pairing* | Start | | |
| Device info | Display | | |

* only visible with installed gateway module.

Using the front-panel controls:

- The SELECT knob is used to select any item within the menu system.
- To change a selected menu item, press the SELECT knob to confirm your choice, then adjust the value by rotating the knob.
- After making the adjustment, press the SELECT knob again to adopt the new setting.
- You can interrupt the process at any time by touching the **MENU** button; in this case any changes you have made are discarded.
- Holding the SELECT knob pressed in takes you one level further down in the menu system.
- Touch the **MENU** button again to quit the menu.

Using the remote control handset:

- Use the **▲** / **▼** buttons to select an item in the menu.
- If you wish to change a selected menu item, first press the **OK** button, and then use the **◀** / **▶** buttons to alter it.
- **After making the change, press the **OK** button again to accept the new setting.**
- You can press the **■** button at any time to interrupt the process; the change is then abandoned.
- Press the **SYS** button again to leave the menu.



Source names menu item

At this menu item you can activate and disable external sources, and assign a plain text name to each source; this name then appears in the screen displays. When you call up this menu item using the **OK** button, a list of all the external sources of the **MP 2000 R** appears. Each source is followed by the assigned name, or if you have disabled the source concerned the note 'disabled'.

If you want to activate / disable a source, or change the plain text name, navigate to the appropriate line.

To activate a source, press the green **☺** button; pressing the red **☹** button disables the source.

To change the plain-text name, move to the appropriate line and press the **OK** button. Now use the alpha-numeric keypad of the **FM2000** to change the name as required, then confirm your choice with **OK**; this saves the settings for that source.

The  button is used to switch between numeric and alpha-numeric input, and between capitals and lower-case letters. Letters can be erased by pressing the  button.

If you should wish to restore the factory default source name, erase the whole name before saving the empty field with the  button: this action resets the display to the standard source names.



The only available method of entering the name is to use the alpha-numeric keypad on the remote control handset.

Display Brightness
menu item
(screen brightness)

At this point you can adjust the brightness of the integral screen to suit your personal preference for normal use.

Display Mode
menu item

This menu item offers the choice between three different display operation modes:

- Always on
- Temporary
- Always off

Selecting '**Temporary**' will switch the display is on for a short while each time the **MP 2000 R** is being operated. Shortly after operation the display will be switched off again automatically.



The brightness of the display can be adjusted separately with the menu item '**Display Brightness**' (see above).

Language
menu item

In this menu item you define the language to be used for the displays on the screen of the front panel of the **MP 2000 R**.

The language used for data transferred to the machine, e.g. from an iPod or other Internet radio station, is determined by the supplying device or the radio station; you cannot define the language on the **MP 2000 R**.

Menu point
Device name

This menu point can be used to assign an individual name to the **MP 2000 R**. In a home network the device then appears under this name.

If an amplifier is connected via the **R2Link** connection, then the amplifier is able to accept this name automatically, and display it on the screen.



The amplifier only accepts this name if an individual name has not already been assigned at the amplifier itself.

Energy Saver
menu item

The **MP 2000 R** features two stand-by modes: ECO Standby with reduced stand-by current drain, and Comfort Standby with additional functions, but slightly higher current drain. You can select your preferred stand-by mode in this menu point:

On (ECO standby):

Active functions in ECO standby mode:

- Power-on at the device itself, or by remote control.
Automatic power-down after ninety minutes without signal (only possible with certain sources).

Off (Comfort standby):

The following expanded functions are available:

- On / Off button illuminated in stand-by mode.
- Unit can be switched on using the app.
- Can be switched on using the **FD100** radio remote control handset (the **FD100** is an optional accessory)
- The automatic power-down function is disabled in Comfort standby mode.

FD 100 pairing
menu item

The **MP 2000 R** can be controlled remotely using the **FD 100** bi-directional radio remote control handset if a Gateway module is installed; this is available as an optional extra.

When you call up this menu point, the **MP 2000 R** attempts to create a connection with the **FD 100** radio remote control.



The menu item is only visible, if a gateway module is installed.

Menu item
Device Info

At this menu point you will find information on the status of the installed software and the factory reset.

Sub-point
Update package

This point displays the currently installed software package.

Sub-point
Control

Display of the control software version

Sub-point
Client

Display of the Streaming Client software version

Sub-point
DAB / FM

Display of the tuner software version.

Sub-point
Decoder

Display of the CD mechanism decoder software

Sub-point
Bluetooth

Display of the Bluetooth module software

Sub-point
Update

At this point it is possible to initiate a firmware update. The update can be accessed from a USB stick or an Internet connection.

Sub-point
Default settings

Calling up and confirming this menu point erases all personal settings, and restores the machine to the state as delivered (factory defaults).





D/A Converter Settings

A number of special settings are available for the **MP 2000 R** D/A converter; they are designed to fine-tune the characteristics of your amplifier to suit your listening preferences.

 The following settings can only be called up if PCM-encoded audio is being played.

Calling up and operating the D/A converter options

Briefly press the  button on the remote control handset in order to call up the D/A converter set-up options. This action opens a set-up window in which the various options are displayed.

- Now use the  /  buttons to select a set-up option.
- In each case the displayed option can be altered using the  /  buttons.
- Press the  button again to leave the menu.

DSP set-up option Oversampling (OVS)

The **MP 2000 R** can exploit four different filter types offering different tonal characters:

- Oversampling **FIR long** is a classic FIR filter with an extremely linear frequency response.
- Oversampling **FIR short** is a FIR filter with improved peak handling.
- Oversampling **Bezier / FIR** is a Bezier interpolator combined with a IIR filter. This process produces a result very similar to an analogue system.
- Oversampling **Bezier** is a pure Bezier interpolator – offering perfect “timing” and dynamics.

 Please refer to the Chapter '**Technical description - Digital filters / Oversampling**' for an explanation of the different filter types.

DSP set-up option Output phase

With particular instruments or voices the human ear is certainly capable of detecting whether absolute phase is correct or not. However, absolute phase is not always correctly recorded.

In this menu item the phase of the signal can be changed from normal to inverse phase and back.

 The correction is carried out at the digital level, and has absolutely no adverse effect on sound quality.

Operating the source devices in detail

Operation with the FM2000 remote control

The operation of the source devices is described in the following chapters using the **FM2000** remote control because only with this remote control all functions of this device can be operated (e.g. adding favourites).

Operation of the MP 2000 R with controls on the front panel of the device

The front panel controls can be used to operate the basic functions of the **MP 2000 R**.

The Navigation/Control rotary control (SELECT knob) can be used to navigate through lists and menus or to control the CD player in the same way as the cursor and OK buttons of the **FM2000** remote.

In Lists

- Choose a list or menu item by turning the SELECT knob.
- By pressing the SELECT knob you can select an item or start playback of a title or station.
- A long press on the the SELECT knob leaves a submenu or navigates to the parent menu level (BACK).
- By pressing the SELECT knob for a longer time you can return to the main menu (HOME).
- When in the main menu a brief press on the -button toggles between the USB inputs (front/back USB inputs)

CD Mechanism Control



- Turning the SELECT knob lets you select a track on the CD.
- When the desired track number lights up on the display this track can be started by pressing the SELECT knob.



Operating the Radio



Selecting the radio



Switching the FM / DAB reception mode

The **MP 2000 R** features both an **FM tuner** and a **DAB / DAB+** reception section (digital radio).

To listen to the radio, first select your preferred radio source: **FM** or **DAB**. This is accomplished with a brief press of the  button on the machine's front panel - repeated if necessary - until the screen displays the appropriate reception mode. On the **FM2000** a brief press on the  button of selects the radio function you wish to use. Press the button twice to switch between **FM and DAB radio**.

When used within a system which includes a **PA 2000 / 2500 R** amplifier, you can also select the reception mode by pressing the  button on the **FM2000** remote control handset: briefly press the  button - repeatedly if necessary - until the screen displays the appropriate reception mode.

Alternatively hold the  button pressed in until the screen displays a Source Select menu. You can now select your preferred source, and activate it by pressing the  button.

 If your system does not include a **T+A** amplifier, and you control the **MP 2000 R** directly using the **FM2000**, you can switch the reception mode between FM / DAB directly using the  button, instead of the  button.

 **Favourites lists**
Separate Favourites lists are available for FM and DAB reception, with the aim of helping you to manage your favourite stations conveniently.

 Depending on the frequency band (block), it may take up to two seconds to switch stations when in **DAB mode**.

Device display

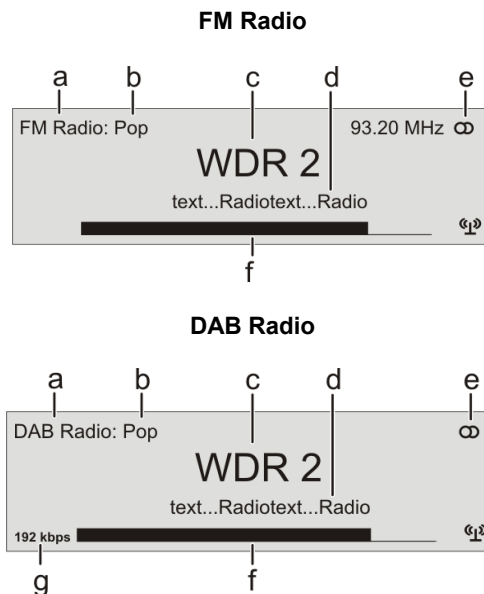

- a) Displays the type of reception currently in use.
- b) Hear the music type or style is displayed, e.g. Pop Music.
This information is only displayed if the transmitting station broadcasts it as part of the *RDS* system. If you are listening to a station which does not support the *RDS* system, or only supports it in part, these information fields remain empty.
- c) The frequency and / or the station name is displayed in enlarged form. If a station name is displayed, its frequency is shown in area 'e'.
- d) These lines display information which is broadcast by the station (e.g. Radiotext).
- e) Display of Stereo '∞' / Mono '●'
- f) The *field strength* (f) and therefore the reception quality to be expected from the set transmitting station can be assessed from the field strength.
- g) Bit-rate of the broadcasting station when listening to DAB radio.
* The higher the bit-rate, the better the station's sound quality.

RDS functions



If the station being received is broadcasting relevant RDS data, the following information will be displayed on the screen:

- **Station name**
- **Radiotext**
- **Program type (genre)**

For stations that do not support the RDS system or only partially or with weak reception, no information will be displayed.

Switching Radio Text on and off

The Radio text function can be switched on and off by briefly pressing the  button on the remote control handset.

Mono / Stereo (only FM – Radio)

You can toggle the radio of the **MP 2000 R** between stereo and mono reception by briefly pressing the  button. The reception mode is shown on the screen by the following symbols:

'●' (Mono) or '◐' (Stereo):

If the station you wish to listen to is very weak or very distant, and can only be picked up with severe background noise, you should always switch to MONO mode as this reduces the unwanted hiss significantly.



The Mono and Stereo symbols are only shown in the detailed screen display.







When you store the station in the Favourites list, the settings you enter for this station are also stored, and are automatically restored the next time you call up the station.

Manual adjustments

(Only available for FM radio!)

Station Search *

Holding one of the  /  buttons pressed in initiates a station search for FM tuner in the upward or downward direction. The station search stops automatically at the next station. A frequency can be selected directly by pressing the  /  buttons repeatedly.





The manual station search can be carried out on the machines front panel by rotating the SELECT knob. A brief press on the rotary knob switches between manual frequency selection and favourite selection.

As soon as the station is audible, you can add it to your Favourites list by pressing the  button.



At the machines front panel, a brief press on the rotary knob switches between manual frequency selection and favourite selection.

Adding stations to the Favourites list

First set the desired station manually (by briefly pressing the  /  buttons) or using a search (holding the  /  buttons pressed in). As soon as the station is audible, you can add it to your Favourites list by pressing the  button.

Favourites List

Favourites List and Presets



In addition to manual tuning and searching, the radio of the **MP 2000 R** also features a **Favourites list** and **Presets**, which provide a fast, convenient method of managing your preferred stations and calling them up at any time.

The Favourites list can store up to 60 FM stations and up to 120 DAB stations. You can edit the lists conveniently at any time.

It is also possible to store 10 stations under a station number (Preset), and then to call it up directly by entering the station number. Presets are particularly useful if you wish to call up stations when the screen is not in sight (e.g. from an adjacent room), or via the domestic control system.

Creating the Favourites list

(Automatic station scan)

To create a Favourites list, the first step is to select one of the two possible reception modes (VHF or DAB). Once you have called up the Favourites list by pressing the  button, you can call up the Favourites menu by pressing the  button. The following Select points are available:



| Manage Favourites | |
|---------------------|-------------|
| Sort Favourites by | Stationname |
| Create new fav-list | Start |
| Add new stations | Start |

To create a new Favourites list, select the "**Create new Favourites list**" menu point and press the  button to start the station search. The screen displays "**Station scan**", and the **MP 2000 R** now automatically stores the stations it can receive in the Favourites list. If a Favourites list already exists, this process overwrites it.

To search for new stations and add them to the list, select the "**Add new stations**" menu point and press the  button to start the station search. All new stations located are now automatically added to the existing list.

 When setting up the **DAB** station list it is advisable to sort them in blocks, otherwise you may experience quite long change-over times when switching stations.

Erasing stations from the Favourites list

Open the Favourites list by pressing the  button. Select the station you wish to erase from the list, hold the red  button pressed in for a few seconds: the station is now removed from the Favourites list. After the erasure the tuner automatically switches to the next station in the Favourites list.



Sort function

The Favourites list can be sorted according to various criteria; these are selected in the menu point '**Sort Favourites by**':

Frequency Stations are sorted by frequency in ascending order (RDS stations only) *1)

Station name Stations are sorted alphabetically by station name

Program ID Stations are sorted by station group (RDS stations only)







Now use the  /  buttons to select the desired sort criterion, and confirm your choice by pressing the  button.

 1) Sorting stations by "frequency" is not possible with DAB stations, as in some cases several stations use the same frequency (channel). In this case the sorting can only be done in blocks.

Selecting radio stations from the Favourites list





Call up the Favourites list with the  button.



- Now use the  /  buttons or the SELECT knob on the front panel to select a stored station from the Favourites list; the selected station is displayed in enlarged form.
- To select the enlarged station for playback, press the  or  button on the remote control handset, or briefly press the SELECT knob on the machine.
- You can return to the previously selected station (i.e. interrupt the process) using the  button on the remote control handset, or with a long press on the SELECT knob on the machine itself.
- Position display in the Favourites list.
You can also select stations directly, without calling up the Favourites list as described above, by briefly pressing the  /  buttons in the Favourites list.

Presets



Storing a Preset

- Select a station, either using the  /  buttons, or from the Favourites list.
- Call up the Store Preset function by pressing the  button.
- An input window now appears in which you can enter a number using the numeric buttons ( to ). The Preset is stored when you press a numeric button. The front panel screen briefly displays the message '**Preset Stored at**' to confirm this.



If a station is already stored at this Preset number, it is overwritten by the new station.

Calling up a Preset



At any time you can quickly call up a station stored as a Preset by entering its Preset number using the **FM2000's** numeric buttons  to .

Operating the CD player



Selecting the CD player as source

First select the CD Player as source, either using the **IN2** button on the **FM2000** or by repeatedly pressing the  button on the front panel of the **MP 2000 R**.

Inserting a CD

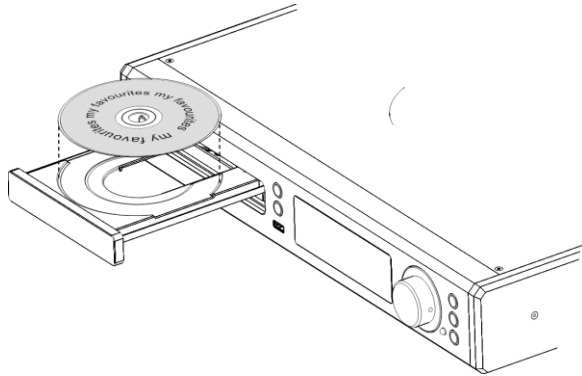
- Open the CD drawer ( on the front panel /  FM2000)
- Place the disc **centrally** in the appropriate depression in the drawer, **with the side to be played facing down**.





- Close the CD drawer ( on the front panel /  FM2000)

When you close the drawer, the machine immediately reads the CD's 'Table of Contents'; the screen displays the message **'Reading'**. During this period all button-presses are ignored.

The screen then displays the total number of tracks on the CD in the drawer, e.g.: **'13 Tracks 60:27'**.

- It is also shows the current mode of operation, e.g. 

Front panel display

 In CD mode the **MP 2000 R** can be switched to either of two different screen displays with a long press on the  button:

- **Large-format display:**
Enlarged display of the most important information, clearly legible even from a distance
- **Detail display:**
Small-text display showing a large number of additional information points, e.g. bit-rate etc.



Fig.
Large format display

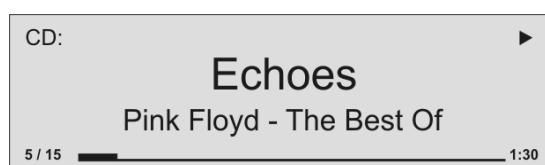



Fig.
Detail display



Playing a CD

Press the rotary knob on the front panel or the  button FM2000 remote control handset to begin the playback process.

Playback starts, and the screen shows the mode of operation () and the number of the track currently being played: **'Track 1'**.

The CD stops after the final track, and the screen again displays the total number of CD tracks and the overall running time.

Variations

If you press the  /  button after placing the CD in the machine, the drawer closes and playback starts with the first track.

The open drawer also closes if you enter the number of a track using the remote control handset.

You can interrupt playback at any time by pressing the  button. During the interruption the screen displays the **||** symbol.

Press the  button again to resume playback.



Briefly pressing the  button during playback causes the player to skip to the start of the next track.

Briefly pressing the  button during playback causes the machine to skip back to the start of the preceding track.

A brief press on the  button concludes playback.

A long press on the  button opens the CD drawer.

Track Select During playback

Briefly press the  or  button on the FM2000 repeatedly until the number of the track you want to hear appears on the integral screen.

Releasing the button interrupts playback briefly, and after this the desired track is played.

 You can also enter the number of the desired track directly using the numeric buttons on the remote control handset.

Playback mode

Repeat



The CD player in the **MP 2000 R** features various playback modes. During playback the current playback mode is shown on the screen.

Brief press:

Repeatedly pressing the  button causes the machine to cycle through different playback modes.

| | |
|------------------------------------|---|
| 'Repeat All' / 'Repeat Program' | The tracks of the CD or a <i>playback program</i> are continuously repeated in the preset sequence . |
| 'Repeat Track' | The track of the CD or a <i>playback program</i> which has just been played is continuously repeated. |
| 'Normal' / 'Program' | Normal playback of the whole disc, or normal program playback. |

Mix mode

Long press:

Holding the  button pressed in switches the machine to Mix mode. A second long press ends Mix mode.

| | |
|--------------------------|---|
| 'Mix' / 'Mix Program' | The tracks of the CD or of a <i>playback program</i> are played in a random sequence . |
|--------------------------|---|

In Mix mode the Repeat function can be called up with a brief press of the  button.

| | |
|-------------------------------------|--|
| 'Repeat Mix' / 'Rpt Mix Program' | The tracks of the CD or of a <i>playback program</i> are continuously repeated in a random sequence . |
|-------------------------------------|--|

Fast Search

• Fast forward search (hold the  button pressed in)

• Fast reverse search (hold the  button pressed in)

Holding the button pressed in for a long period increases the rate (speed) of search. During the search process the screen displays the current track running time.

Playback Program

Creating a Playback Program

Explanation:

A playback program consists of up to thirty tracks of a CD stored in any order you like. This can be useful, for example, when you are preparing a cassette recording. A playback program can only be created for the CD currently in the disc drawer of the **MP 2000 R**. The program remains stored until it is erased again, or until the CD drawer is opened.



Operation:

When you place the CD in the drawer, the screen displays the total number of tracks on the disc, e.g.: **'13 Tracks 60:27'**. For creating a playback program the disc must be stopped.





- Activating playback programming mode.

Press the  button

The screen displays the message **'Add Track 1 to Program'** and **'0 Tracks / 0:00 Program time'**.

- Repeatedly press the  or  button briefly until the number of the desired track appears on the screen after **'Track'**.
- Now store the track in the playback program by briefly pressing the  button.

The screen shows the number of tracks and the total playing time of the playback program. Select all the remaining tracks of the program in the same manner, and store them by briefly pressing the  button.

 It is also possible to enter the track directly using the numeric buttons, instead of using the  /  buttons. After you enter the number, press the  button briefly to store the track, as described above.

If you store thirty tracks, the screen displays the message **'Program full'**.

The playback programming process is concluded when all the desired tracks have been stored.

- End the playback programming process.



Hold the  button pressed in for about one second

Playing a playback program

The playback program can now be played.

- Start the playback process.  button

Playback starts with the first track of the playback program. The screen displays the message **'Program'** while a playback program is playing.

The  and  buttons select the previous or next track, but only within the playback program.

Erasing a playback program

Briefly pressing  button in **STOP** mode opens the CD drawer, and thereby erases the playback program.

A playback program can also be erased without opening the CD drawer:

- Erase the playback program.

Hold the  button pressed in again for about one second

The playback program is now erased.

Operating the Streaming Client

General Information on the Streaming Client

The **T+A MP 2000 R** includes what is known as a 'Streaming Client'. This is a new class of playback devices for media content, providing a means of playing music which is stored on a vast variety of sources. These sources may be an USB hard disc connected directly to the **MP 2000 R**, but they may also be thousands of miles away (e.g. Internet radio station). The Streaming Client can access such remote sources via a home network and the Internet.

 The network configuration is explained in the Chapter '**Network Configuration**'.

The **MP 2000 R** Streaming Client can access the following sources:

| Local sources (direct connection) | Remote sources (via home network or Internet) |
|---|--|
| USB memory sticks and USB hard discs | Internet radio |
| | NAS server (with UPnP-AV server) |
| | PC (with UPnP-AV server) |

The media content formats which the **MP 2000 R** can reproduce are very wide-ranging, and extend from compressed formats such as MP3, WMA, AAC and OGG Vorbis to high-quality non-compressed data formats such as FLAC and WAV, which are thoroughly audiophile in nature. A full listing of all possible data and playlist formats is included in the Specification, which you will find in the Appendix to these instructions.

Since virtually no read or data errors occur when electronic memory media are accessed, the potential reproduction quality is even higher than that of CD. The quality level may even exceed that of SACD and DVD-Audio.

The **MP 2000 R** can also play back high-resolution audio formats (FLAC and WAV up to 192kHz / 32bit). High-resolution audio files can be played back from a USB hard disc connected to the unit, or via a network connection. However, if you wish to use a network for 192/32 reproduction, a cable network must be used since a WLAN network is not generally sufficient for the high data rates (see also the note in the chapter entitled '**Network configuration**').













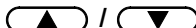

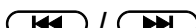
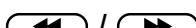

Select Lists

The music content to be played is chosen from Select Lists. These lists are operated using the navigation buttons (cursor buttons) which you will find on the remote control handset and on the front panel. All content can be accessed via the main menu. Internet Radio in particular offers a huge number of stations, which can result in long searches or periods of navigation. We therefore recommend that you store your preferred stations in a **Favourites List**, as this makes them easy and fast to access, with no protracted searching. It is also possible to store Internet radio stations as **Presets**, just as you do with normal radio; they can then be called up directly just by entering a number.

The media content can be listed according to various criteria - Internet radio stations e.g. by country of origin, genre or alphabetical, music from media servers e.g. by artiste, album, track, genre, etc.

 The exact form of the displayed list and the preparation of the content also depend to a large extent on the capabilities of the server, i.e. the full facilities of the **MP 2000 R** cannot be exploited with all servers or media. You may therefore find that in many cases not all the functions described in these instructions can be used.

The following table shows the buttons on the remote control handset and their basic function when operating the Streaming Client:

| | |
|--|---|
|  | Selects the Streaming Client as listening source. |
|  | Brief press: Switches to the main list (Home function) Long press: Opens the Configuration menu |
|  | While the main menu is displayed: A brief press toggles between the inputs USB 1 (back panel) and USB 2 (front panel). |
|  | Selects the menu item within a list |
|  | Opens a folder , starts a piece of music or playlist |
|  | Back to the next higher menu level |
|  | Plays the selected track or folder During input operations: confirms the input |
|  | Selects the previous or next piece in the playback list. Hold button pressed in for fast forward and rewind search. |
|  | Hold button pressed in for fast forward and rewind search. |
|  | Ends playback (STOP) |
|  | • Starts playback (PLAY function) • Halts playback (PAUSE) or mute and resume, if available |
|  | Long press: Removes a favourite from the Favourites list created on the MP 2000 R |
|  | Adds a favourite to the Favourites list created on the MP 2000 R . If no memory space is available, the screen displays the message 'Favorite List Full'. |
|  | Displays the Favourites list created on the MP 2000 R . |
|  | <i>Preset store button</i> |
|  (not possible with all media) | Repeated brief presses cycle through the repeat functions: → Rpt Trk, → Rpt All, → Normal Rpt Trk The current piece is repeated Rpt All All pieces in the current folder / the current playlist are repeated Normal Repeat function switched off Long press: Switches Mix mode (Shuffle) ON and OFF Subsequent brief button presses will cycle through the Mix Repeat operating modes: → Mix, → Rpt Trk, → Rpt Mix In Mix mode the pieces are played in a random order. |
|  | During character input operations: Toggle switch: when pressed repeatedly this button toggles between numeric and alpha-numeric input, and between capitals and lower case While navigating through lists: Calls up the Search function (Alpha search) |
|  | A long press is used to switch between two different front panel display modes. |

Screen

All information relating to machine status, the current music track and navigation in lists is displayed on the **MP 2000 R** graphic screen. The display is context-sensitive, and varies in part according to the capabilities and facilities of the service to which you are currently listening.

The essential information is displayed in enlarged form in the main line of the screen. Supplementary information is shown above and below it in smaller lettering, or by symbols. The table below shows and explains the symbols employed.

i The **MP 2000 R** provides different screen displays for the Streaming Client. A long press on the -button on the remote control handset is used to switch between the display modes.

- **Large-format display:**
Enlarged display of the most important information, clearly legible even from a distance
- **Detail display:**
Small-text display showing a large number of additional information points, e.g. bit rate etc.



Fig.
Large format display

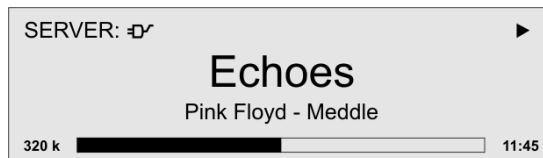

Fig.
Detail display

Access to Media Content via the Main Menu (Home Menu)

Main Menu (Home-Menu)

When you call up the Streaming Client by pressing the **IN1/MP** button of the **FM2000**, the front panel screen displays a list containing the devices connected to the system, or accessible via the network, together with the Favourites folder, e.g.:

- USB / iPod *1)
- Internet Radio
- UPnP-AV Server (Media server) in the local network *2)
- Favorites



- i** *1) Only the selected USB input is displayed. Use a brief press on the **IN1/MP** button on the remote control or on the front panel to switch between the USB inputs.
- i** *2) To play back media files that are stored on PC's or NAS storage devices on your home network, a UPnP-AV server software must be installed on these devices to make the media content accessible through the network.

Selecting and Playing Media Content

You can now select a device or a service using the **▲** / **▼** buttons. The selected list item is shown enlarged, and can be called up by pressing the **OK** / **▶** button.

The content of the device is displayed in the form of a list. The individual list entries are followed either by a folder symbol (**□**) or a note symbol (**♪**).

You can now again move to the individual list points using the **▲** / **▼** buttons, and open them with the **OK** / **▶** button.

If the list entry you open is a folder, the screen displays the contents of the folder: you can now navigate further within the new folder.

If the entry is followed by a note symbol, this indicates that the content is playable (pieces of music, playlists, radio station etc.). If you open an entry of this type, its content will be played.

- i** The lists and music tracks you can see when you select a device vary according to the machine and the transferred data.

Alpha-Search (Letter Search Function)

When you are navigating through lists you can call up the **MP 2000 R** letter search function at any time by briefly pressing the **▲▼** button. The screen now displays the message 'Search _'. While this is on the screen, enter up to five letters or numerals using the remote control handset; the letters assigned to the numeric buttons are printed below the buttons. To obtain a particular letter, press the appropriate button repeatedly until the correct letter appears on the screen. Before entering the next character you have to wait until the cursor is displayed again. After pressing the **v** button or after a brief delay with no further input the **MP 2000 R** moves to the first entry in the list which starts with the characters you entered.

- i** If the text searched for is not found the best matching result will be shown. You can abort the search using the **—** button.

Accessing Media Content using the Favourites List

The Favourites List

The Favourites list can be used to store your preferred Internet radio stations and the paths to your preferred music tracks. At any subsequent time you can then very quickly access these stations and tracks using the 'Favorites' entry in the Home Menu.







Adding Favourites to the List

If you are currently enjoying a particular Internet radio station, simply press the green  button on the FM2000 handset: this adds the station to the Favourites list.





In principle you can also add pieces from a NAS server or a USB hard disc to your Favourites list, but we only recommend this if the content of the relevant storage medium is available at all times (e.g. permanently connected USB hard disc).

Calling up Favourites

Open the Favourites list using the  button, then select an entry from the list using the  /  buttons. Start the track or the station by pressing the  /  /  button.

Erasing Favourites

Entries are removed from the Favourites list by first selecting the entry to be erased using the  /  buttons, and then holding the red  button on the FM2000 handset pressed in for several seconds.



Caution!



Erase the paths to files on USB hard discs or UPnP-AV servers from the Favourites list using the  button before you erase or move files.



Using Presets

Preset function



You can store Internet radio stations as **Presets** using the process familiar from FM radio. These stations can subsequently be called up directly using the numeric buttons on the **FM2000** remote control handset.

Storing a Preset

First select an Internet radio station (e.g. using the Home menu / Internet radio). When you hear the station, press the  button followed by a number  to . The station is now stored under this number.

It is possible to store a total of ten Presets under the numbers  to .

Calling up a Preset

Briefly press one of the numeric buttons  to . The associated Preset is now called up, and after a brief delay you will hear it.



Presets are particularly useful when the front panel screen is not in view, but you wish to call up stations (e.g. when operating the system from an adjacent room, or when operating it via a domestic control system).

Adding Internet Radio Stations

The lists of Internet radio stations displayed by the **MP 2000 R** are very complete and comprehensive, but since new stations are constantly being added you may find that one of your favourite stations is not (yet) included in the Select lists.



In this case you can add the stations using the vTuner service (see also the Chapter '**vTuner Premium Service**'). The station added can then be accessed from the **MP 2000 R** main menu under the Internet Radio / Added Stations point.

Operating the Bluetooth source

The **MP 2000 R**'s integral Bluetooth interface provides a means of transferring music wirelessly from devices such as smart-phones, tablet PCs, etc. to the **MP 2000 R**.

 For a successful audio Bluetooth transfer from a mobile device to the **MP 2000 R** the mobile device must support the A2DP Bluetooth audio transfer protocol.

Selecting the Bluetooth Audio source

Select the 'Bluetooth' source by repeatedly pressing the  button on the remote control handset, or the  button on the **MP 2000 R**'s front panel.

The machine's integral screen now displays 'Bluetooth' as source.

Setting up audio transfer

Before music from a Bluetooth-capable device can be played through the **MP 2000 R**, the external device must first be registered to the **MP 2000 R**. As long as the **MP 2000 R** is switched on and no device is connected, it is always ready to receive. In this state the screen displays the message 'not connected'.

This is the procedure for establishing a connection:

- Start a search for Bluetooth equipment on your mobile device.
- When it finds the **MP 2000 R**, make the connection to your mobile device.

Once the connection is successfully established, the message on the **MP 2000 R**'s screen switches to 'connected to *YOUR DEVICE*'.

 If your device requests a PIN code, this is always '0000'.

 The procedure for establishing a connection can only be made if the Bluetooth source is activated (see chapter "**Basic settings of the MP 2000 R**").

 Due to the large number of different equipment on the market, we are only able to provide a general description for setting up the radio connection. For detailed information please refer to the operating instructions supplied with your device.

Playback functions

Information on the piece of music being played is displayed on the integral screen of the connected mobile device. If possible we recommend that you leave the screen backlight switched on permanently to ensure that it is clearly legible.

The behaviour and method of operating the connected mobile device are determined by the device itself. In general terms the function of the buttons of the **MP 2000 R** or the **FM2000** remote control handset are as follows:

Start and pause playback

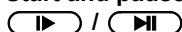

The  buttons on the remote control handset or the front panel are used to start and pause playback (PLAY / PAUSE function).

Stop playback



Pressing the  button halts playback.

Switch track

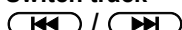

A brief press on the  buttons during playback causes the device to jump to the next or previous piece of music within the current playlist.

 Please note that many AVRCP-capable mobile devices do not support the controlling through the **MP 2000 R**. In case of doubt, please ask the manufacturer of your mobile device.

Controlling the MP 2000 R

The **MP 2000 R** can also be controlled from the mobile device (Start/Stop, Pause, Volume, etc.). To control the **MP 2000 R** the mobile device must conform to the Bluetooth AVRCP protocol.



Please note that many AVRCP-capable mobile devices do not support all the **MP 2000 R**'s control functions. In case of doubt, please ask the manufacturer of your mobile device.

NOTES



The **MP 2000 R** has been tested with a large number of Bluetooth-capable mobile devices. However, we are unable to guarantee general compatibility with all devices available commercially since the range of equipment is so wide, and the various implementations of the Bluetooth standard differ widely in some cases. If you encounter a problem with Bluetooth transfer, please contact the manufacturer of the mobile device.

The maximum range of a Bluetooth audio transfer is normally about 3 to 5 metres, but the effective range may be affected by a number of factors. To achieve good range and interference-free reception there should be no obstacles or persons between the **MP 2000 R** and the mobile device.

Bluetooth audio transfers take place in what is known as the “everyman frequency band”, in which many different radio transmitters operate - including WLAN, garage door openers, baby intercoms, weather stations, etc. Radio interference caused by these other services may cause brief dropouts or - in rare cases - even failure of the connection, and such problems cannot be excluded. If problems of this kind occur frequently in your environment, we recommend that you use the Streaming Client or the USB input of the **MP 2000 R** instead of Bluetooth.

By their nature, Bluetooth transmissions always involve data reduction, and the attainable sound quality varies according to the mobile device in use, and the format of the music to be played. As a basic rule the maximum quality of music which is already stored in a data-reduced format, such as MP3, AAC, WMA or OGG-Vorbis, is worse than with uncompressed formats such as WAV or FLAC. For the highest reproduction quality we always recommend the use of the Streaming Client or the USB input of the **MP 2000 R** instead of Bluetooth.



„© 2013 CSR plc and its group companies. The aptX® mark and the aptX logo are trade marks of CSR plc or one of its group companies and may be registered in one or more jurisdictions.”

The MP 2000 R as D/A Converter

General Information on D/A Converter Operation

The **T+A MP 2000 R** can be used as a high-quality D/A converter for other devices such as computers, streamer, digital radios etc. which are fitted with poor-quality converters or no converter at all. The **MP 2000 R** features two optical and two electrical S/P-DIF digital inputs on the back panel to allow this usage.

A USB-DAC input on the back panel permits to use the **MP 2000 R** as D/A converter for computers.

i You can connect devices with electrical co-axial or optical light-pipe output to the digital inputs of the **MP 2000 R**. At the optical inputs Digital In 3 and Digital In 4 the **MP 2000 R** accepts digital stereo signals conforming to the S/P-DIF norm, with sampling rates of 32 to 96 kHz. At the electrical co-axial inputs Digital In 1 and Digital In 2 the range of sampling rates is from 32 to 192 kHz.

At the **USB DAC IN** input the **MP 2000 R** accepts digital PCM-encoded stereo signals with sampling rates of 44.1 to 384 kHz (32-bit) and DSD data with sampling rates of DSD64, DSD128 and DSD256.

If you wish the **MP 2000 R** to convert audio files from a Windows PC connected to it, you must first install driver software on the computer (see the chapter entitled '**USB DAC operation in detail**'). If you are using a computer running Mac OS X 10.6 or higher no drivers are necessary.

D/A Converter Operation

Selecting a D/A Converter Source

Select the **MP 2000 R** as listening source on your amplifier.

Choose the digital input to which you have already connected the source device which is to be played by pressing the source button  on the front panel or the **IN3** / **IN4/PH** button on the **FM2000** (repeatedly if necessary).

As soon as the source device delivers digital music data, the **MP 2000 R** automatically adjusts itself to the format and sampling rate of the signal, and you will hear the music.

Screen Display

i During D/A converter operations the **MP 2000 R** integral screen displays the characteristics of the digital input signal.

USB DAC operation in detail

System-requirements

- Intel Core i3 or higher or a comparable AMD Processor.
- 4 GB RAM
- USB 2.0 Interface
- Microsoft Windows XP, Microsoft Windows Vista, Microsoft Windows 7 / 8
- or MAC OS X 10.6.+

Installing drivers

The **MP 2000 R** can be operated with the listed MAC operating systems without requiring the installation of a driver. Playback of DSD streams up to DSD128 and PCM streams up to 384 kHz is possible with MAC operating systems.

If the device is to be operated in conjunction with one of the stated Windows operating systems, a dedicated driver must first be installed. With the driver installed, it is possible to play DSD streams up to DSD128 and PCM streams up to 384 kHz.

If an additional ASIO driver is installed on a Windows system, DSD streams up to DSD256 can also be played.

-  The drivers required, together with detailed installation instructions including information on audio playback via USB, are available for downloading from our website at <http://www.ta-hifi.com/MP2000R-software>

Settings

A number of system settings have to be altered if you wish to operate **MP 2000 R** with your computer. These changes must be made regardless of the operating system. The installation instructions provide detailed information on how and where the settings are to be changed.

Notes on software

-  By default, the operating systems listed above do not support 'native' music playback. This means that the PC always converts the data stream to a fixed sample rate, regardless of the sample rate of the file to be played. Separate software is available - e.g. J. River Media Center or Foobar - which prevents the operating system converting the sample rate. The installation instructions included in the driver package contain further information on audio playback via USB.

Notes on operation

-  To prevent fail functions and system crashes of your computer and the playback program, please note the following:
- For Windows OS: Install the driver before you use the **MP 2000 R** for the first time.
 - Use only drivers, streaming methods (e.g. WASAPI, Directsound) and playback software which are compatible to your operating system and between each other.
 - Never connect or disconnect the USB connection while the system is running.

Notes on setting up

-  Do not set up the **MP 2000 R** on or immediately adjacent to the computer to which it is connected, otherwise the device could be affected by interference radiated by the computer.

Installation

Using the system for the first time

Safety notes

This section describes all those matters which are of fundamental importance when setting up and first using the equipment. This information is not relevant in daily use, but you should nevertheless read and note it before using the equipment for the first time.

Back panel connections

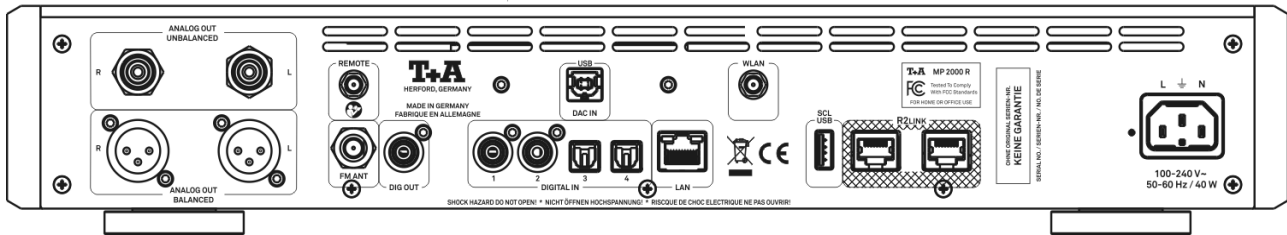

ANALOG OUT

BALANCED

The symmetrical XLR output delivers analogue stereo signals with a fixed level. It can be connected to the CD-input (line input) of any stereo pre-amplifier, integrated amplifier or receiver.



If both types of connection are present on the connected amplifier, we recommend the symmetrical option to obtain the best possible sound quality.

UN-BALANCED

The unbalanced RCA output of the **MP 2000 R** delivers analogue stereo signals with a fixed level. It can be connected to the CD-input (line input) of any stereo pre-amplifier, integrated amplifier or receiver.

FM ANT

(aerial input for FM and DAB Radio)

The **MP 2000 R** features a 75 Ω aerial input **FM ANT**, which is suitable both for a normal domestic aerial and a cable connection. For first-class reception quality a high-performance, professionally installed aerial system is indispensable.

REMOTE

The socket for the aerial of the optional radio remote control module can be installed here. This is required for communication with the **T+A FD 100** radio remote control handset, which is available as an **optional accessory**.

DIGITAL OUT

Digital co-axial output for connection to an external digital/analogue converter with an co-axial cable.



It is not always possible to produce a digital version for all media, as in some cases the original contains copy protection measures which prevent this.

DIGITAL IN

Inputs for digital source devices with optical or coaxial (RCA) outputs.



At its optical digital inputs the **MP 2000 R** accepts digital stereo signals (S/P-DIF signals) with sampling rates from 32kHz up to 96 kHz. At the coaxial digital inputs sampling rates in the range 32 to 192 kHz are supported.

USB DAC IN

Socket for connecting a PC or MAC computer.

At this input the **MP 2000 R** accepts digital **PCM** stereo signals with sampling rates in the range **44.1 to 384 kSps**, and digital **DSD** stereo signals from **DSD64 to DSD256***.

* **DSD256** only with a Windows PC.



If you wish the **MP 2000 R** to convert audio files from a Windows PC connected to it, you must first install the appropriate drivers on the computer. No drivers are required if you are using a Linux or MAC computer (see the chapter '**USB DAC operation in detail**').

LAN

Socket for connection to a wired LAN (Ethernet) home network.



If a LAN cable is connected this will have priority over wireless WLAN networks. The WLAN module of the **MP 2000 R** will automatically be disabled.

WLAN

Input socket for WLAN antenna

**Automatic Activation of the WLAN Module**

After powering on the **MP 2000 R** detects if it is connected to a wired LAN Network. If no wired LAN connection is found, the **MP 2000 R** will automatically activate its WLAN module and it will try to get access to your WLAN network.

SCL USB

Socket for a USB memory stick or external hard discs

Files from a medium connected to this socket are reproduced via the Streaming Client (SCL). Only audio files can be played in this way.

The storage medium must be formatted using the FAT16 or FAT32 file system.

The USB storage medium can be powered directly via the USB port provided that its current drain is in accordance with the USB norm. Normalised 2.5" USB hard discs can be connected directly, i.e. without a separate mains PSU.

R2LINK

Control input / output for **T+A R2LINK** – systems:

Both sockets are equivalent – one is used as input, the other one serves as output towards other **R2LINK** devices.

Mains in

The mains cable is plugged into this socket.

For correct connections refer to the sections '**Installation and wiring**' and '**Safety notes**'.

Installation and wiring

Carefully unpack the **MP 2000 R** and store the original packing materials carefully. The carton and packing are specially designed for this unit and will be needed again if you wish to move the equipment at any time.

Please be sure to read the safety notes in these instructions.

If the unit gets very cold (e. g. when being transported), condensation may form inside it. Please do not switch it on until it has had plenty of time to warm up to room temperature, so that any condensation evaporates completely.

Before placing the unit on a sensitive surface, please check the compatibility of the lacquer and the unit's feet at a non-visible point.

The unit should be placed on a rigid, level base. When placing the unit on resonance absorbers or de-coupling components make sure that they do not compromise the stability of the unit.

The quality and characteristics of the base on which your high-quality Hi-Fi equipment stands define the limits of sound quality which can be achieved. The base surface should be as heavy, rigid, hard and level as possible.

The receiver should be set up in a dry, well-ventilated site, out of direct sunlight and away from radiators.

The unit must not be located close to heat-producing objects or devices, or anything which is heat-sensitive or highly inflammable.

Naked flame sources, such as candle lights should not be placed on the device.

When installing the unit on a shelf or in a cupboard it is essential to provide an adequate flow of cooling air, to ensure that the heat produced by the unit is dissipated effectively. Any heat build-up will shorten the life of the unit and could be a source of danger. Be sure to leave at least 10 cm free space above the unit for ventilation. If the system components are to be stacked then the amplifier must be the top unit. Do not place any object on the top cover.

Mains and loudspeaker cables, and also remote control leads must be kept as far away as possible from signal leads and antenna cables. Never run them over or under the unit.

A complete connection diagram is shown in '**Appendix A**'.



Notes on connections:

- Be sure to push all plugs firmly into their sockets. Loose connections can cause hum and other unwanted noises.
- When you connect the input sockets of the amplifier to the output sockets on the **MP 2000 R** always connect like to like, i. e. '**R**' to '**R**' and '**L**' to '**L**'. If you fail to heed this then the stereo channels will be reversed.
- The device is intended to be connected to mains outlet with protective earth connector. Please connect it only with the mains cable supplied to a properly installed mains outlet with protective earth connector.
- To achieve maximum possible interference rejection the mains plug should be connected to the mains socket in such a way that phase is connected to the mains socket contact marked with a dot (●). The phase of the mains socket can be determined using a special meter. If you are not sure about this, please ask your specialist dealer.

We recommend the use of the **T+A 'POWER THREE'** ready-to-use mains lead in conjunction with the '**POWER BAR**' mains distribution panel, which is fitted with a phase indicator as standard.

When you have completed the wiring of the system please set the volume control to a very low level before switching the system on.

The screen on the **MP 2000 R** should now light up, and the unit should respond to the controls.

If you encounter problems when setting up and using the amplifier for the first time please remember that the cause is often simple, and equally simple to eliminate. Please refer to the section of these instructions entitled '**Trouble shooting**'.

Loudspeaker and signal cables

Loudspeaker cables and signal cables (inter-connects) have a significant influence on the overall reproduction quality of your sound system, and their importance should not be under-estimated. For this reason **T+A** recommends the use of high-quality cables and connectors.

Our accessory range includes a series of excellent cables and connectors whose properties are carefully matched to our speakers and electronic units, and which harmonise outstandingly well with them.

For difficult and cramped situations the **T+A** range also includes special-length cables and special-purpose connectors (e. g. right-angled versions) which can be used to solve almost any problem concerning connections and system location.

Mains cables and mains filters

The mains power supply provides the energy which your sound system equipment needs, but it also tends to carry interference from remote devices such as radio and computer systems.

Our accessory range includes the specially shielded 'POWER FOUR' mains cable, ready-to-use 'POWER LINE' mains cable with integrated shell-type filters and the 'POWER BAR' mains filter distribution board which prevent electro-magnetic interference from entering your Hi-Fi system. The reproduction quality of our systems can often be further improved by using these items.

If you have any questions regarding cabling please refer to your specialist dealer who will gladly give you comprehensive expert advice without obligation. We would also be happy to send you our comprehensive information pack on this subject.

Care of the unit:

Always disconnect the unit from the mains supply before cleaning it.

The surfaces of the case should be wiped clean with a soft, dry cloth only.

Never use solvent-based or abrasive cleaners!

Before switching the unit on again, check that there are no short-circuits at the connections, and that all cables are plugged in correctly.

Changing the batteries:

Locate the point indicated by the arrow in the left picture, and open the battery compartment by pressing it in and simultaneously sliding back the battery cover. Insert three batteries of the **LR 03 (MICRO)** type in the battery compartment, as shown in the engraved diagram. Please note: it is essential to **replace all three batteries at the same time**.

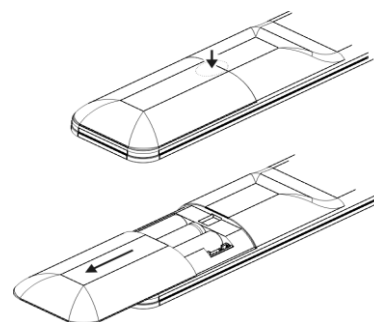

Caution!

Batteries should not be exposed to excessive heat like sunshine, fire or the like.



Disposing of exhausted batteries:

Exhausted batteries must never be thrown into the household waste! They should be returned to the battery vendor (specialist dealer) or your local toxic waste collection point, so that they can be recycled or disposed in a proper way. Most local authorities provide collection centres for such waste, and some provide pick-up vehicles for old batteries.

Safety notes

All the components in this device fulfil the currently valid German and European safety norms and standards.

We ensure that our products are of consistently high quality, and meet all specifications, by checking all materials rigorously for quality, using meticulous production methods and subjecting each unit to a fully automatic computer-controlled final inspection.

For your own safety please consider it essential to read these operating instructions right through, and observe in particular the notes regarding setting up, operation and safety.

Installation

The unit must be set up in such a way that none of the connections can be touched directly (especially by children). Be sure to observe the notes and information in the section '**Installation and Wiring**'.

Power supply

The mains power supply to which the unit is connected must be grounded properly and must meet the current regulations. The power supply required for this unit is printed on the mains supply socket. The unit must never be connected to a power supply which does not meet these specifications. If the unit is not to be used for a long period disconnect it from the mains supply at the wall socket.

Mains leads / Mains plug

Mains leads must be deployed in such a way that there is no danger of damage to them (e. g. through persons treading on them or from furniture). Take particular care with plugs, distribution panels and connections at the device.

Unplugging the mains plug will disconnect the device from the mains for service and repair. Please make sure that the mains plug is easily accessible.

Enclosure openings

Liquid or particles must never be allowed to get inside the unit through the ventilation slots. Mains voltage is present inside the unit, and any electric shock could cause serious injury or death. Never exert undue force on mains connectors.

Protect the unit from drips and splashes of water; never place flower vases or fluid containers on the unit.

Supervision of device operation

Like any other electrical appliance this device should never be used without proper supervision. Take care to keep the unit out of the reach of small children.

Service, Damage

The case should only be opened by a qualified specialist technician. Repairs and fuse replacements should be entrusted to an authorised **T+A** specialist workshop. With the exception of the connections and measures described in these instructions, no work of any kind may be carried out on the device by unqualified persons.

If the unit is damaged, or if you suspect that it is not functioning correctly, immediately disconnect the mains plug at the wall socket, and ask an authorised **T+A** specialist workshop to check it.

Over voltage

The unit may be damaged by excess voltage in the power supply, the *mains circuit* or in aerial systems, as may occur during thunderstorms (lightning strikes) or due to static discharges.

Special power supply units and excess voltage protectors such as the **T+A 'Power Bar'** mains distribution panel offer some degree of protection from damage to equipment due to the hazards described above.

However, if you require absolute security from damage due to excess voltage, the only solution is to disconnect the unit from the mains power supply and any aerial systems.

To avoid the risk of damage by overvoltages we recommend to disconnect all cables from this device and your HiFi system during thunderstorms.

All mains power supply and aerial systems to which the unit is connected must meet all applicable safety regulations and must be installed by an approved electrical installer.



Many insurance companies offer lightning damage insurance for electrical equipment as part of their household insurance service.

Approved usage

This device is designed exclusively for reproducing sound and/or pictures in the domestic environment. It is to be used in a dry indoor room which meets all the recommendations stated in these instructions.

Where the equipment is to be used for other purposes, especially in the medical field or any field in which safety is an issue, it is essential to establish the unit's suitability for this purpose with the manufacturer, and to obtain prior written approval for this usage.

T+A equipment which includes a radio or television receiving section must be operated within the stipulations laid down by the Post Office and the Telecommunications authorities in the country in which it is used.

This unit may only be used to receive or reproduce those transmissions which are intended for public reception. The reception or reproduction of other transmissions (e. g. police radio or mobile radio broadcasts) is prohibited.

Approval and conformity with EC directives

In its original condition the unit meets all currently valid European regulations. It is approved for use as stipulated within the EC.

By attaching the CE symbol to the unit **T+A** declares its conformity with the EC directives **89/336/EEC**, amended by **91/263/EEC**, amended by **93/68/EEC**, and also **73/23/EEC**, amended by **93/68/EEC** and the national laws based on those directives.

The original, unaltered factory serial number must be present on the outside of the unit and must be clearly legible! The serial number is a constituent part of our conformity declaration and therefore of the approval for operation of the device.

The serial numbers on the unit and in the original **T+A** documentation supplied with it (in particular the inspection and guarantee certificates), must not be removed or modified, and must correspond.

Infringing any of these conditions invalidates **T+A** conformity and approval, and the unit may not be operated within the EC. Improper use of the equipment makes the user liable to penalty under current EC and national laws.

Any modifications or repairs to the unit, or any other intervention by a workshop or other third party not authorised by **T+A**, invalidates the approval and operational permit for the equipment.

Only genuine **T+A** accessories may be connected to the unit, or such auxiliary devices which are themselves approved and fulfil all currently valid legal requirements.

When used in conjunction with auxiliary devices or as part of a system this unit may only be used for the purposes stated in the section '**Approved usage**'.

Disposing of this product



The only permissible method of disposing of this product is to take it to your local collection centre for electrical waste..

FCC Information to the user

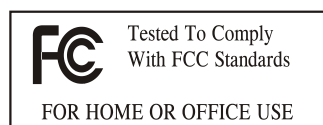

(for use in the United States of America only)

Class B digital device – instructions:

Note: This equipment has been tested and found to comply with the limits for a Class B digital device, pursuant to Part 15 of the FCC Rules. These limits are designed to provide reasonable protection against harmful interference in a residential installation. This equipment generates, uses and can radiate radio frequency energy and, if not installed and used in accordance with the instructions, may cause harmful interference to radio communications. However, there is no guarantee that interference will not occur in a particular installation. If this equipment does cause harmful interference to radio or television reception, which can be determined by turning the equipment off and on, the user is encouraged to try to correct the interference by one or more of the following measures:

- Reorient or relocate the receiving antenna.
- Increase the separation between the equipment and receiver.
- Connect the equipment into an outlet on a circuit different from that to which the receiver is connected.
- Consult the dealer or an experienced radio/TV technician for help.

Network Configuration

General Information

The **MP 2000 R** can be operated in wired LAN networks (*Ethernet LAN* or *Powerline LAN*) or in wireless networks (*WLAN*).

If you wish to use your **MP 2000 R** in your home network, you must first enter the necessary network settings on the **MP 2000 R**. This includes entering the network parameters such as the IP address etc. both for wired and wireless operation. If you wish to use a wireless connection, a number of additional settings for the WLAN network also have to be entered.

Please refer to the Chapter '**Glossary / Additional Information**' and '**Network Terms**' for additional explanations of terminology relating to network technology.

i **In the following sections we assume that a working home network** (cable network of WLAN network) **with router and (DSL) Internet access is present.** If you are unclear about some aspect of installing, setting up and configuring your network, please address your queries to your network administrator or a network specialist.

i **High-resolution audio files via network**
The **MP 2000 R** can also play back high-resolution up to 192 kHz / 24-bit audio formats in the FLAC and WAV formats. A WLAN connection is not generally sufficient to handle the large quantities of data. If you wish to play back high-resolution audio files via a network connection, please use a cable network exclusively.

Compatible hardware and UPnP servers

The marketplace offers a vast number of routers, NAS devices and USB hard discs made by a very wide range of manufacturers. **T+A** equipment is generally compatible with other makes of machine which bear the UPnP label. A list of devices which **T+A** has checked for compatibility can be found on the Internet at: http://www.ta-hifi.de/fileadmin/software/e-serie/MP_HW_KOMP.pdf

Network Configuration Menu

All network settings are entered in the Network Configuration menu. This menu will vary slightly in appearance depending on the type of your network, i.e. whether you have a wired (LAN) or wireless (WLAN) network.

If in the Network Configuration Menu the entry 'Network IF Mode' is set to 'auto', the **MP 2000 R** will check automatically if a LAN connection to a network is present. If a LAN connection is found, the machine will assume that this is to be used, and displays the network configuration menu for LAN networks.

If no LAN network is connected, the **MP 2000 R** activates its WLAN module and displays the WLAN configuration menu when you call up the configuration menu. The menu for a WLAN network includes a number of additional menu points. The following sections explain how to use the menu, and the meaning of the individual menu points.

i The Network IF Mode 'auto' is the default factory setting. In case of problems in combination with your hardware this automatic function can be switched to a fixed operation mode, e.g. only LAN.

Opening the Network Configuration Menu

First select the **MP 2000 R** Streaming Client function by pressing the **SCL** button.

Open the configuration menu with a long press on the **SRC** button on the **FM2000** remote control handset. You should now see the configuration menu on the front panel screen.

Operating the Menu, Changing and Storing IP Addresses

Use the **▲** / **▼** buttons in the menu to select the network parameter to be changed, and activate the entry with the **OK** button.

You can now change the setting using the following buttons, depending on the type of setting:

◀ / **▶** button for simple selection (ON / OFF)

Numeric buttons **0** to **9** for entering IP addresses

Alpha-numeric input for entering text

When the setting process is complete, or when you have entered the complete address, press the **OK** button to confirm your action.

Alpha-numeric entry

At certain points, e.g. for entering server names or passwords, it is necessary to input series of characters (strings). At such points you can enter letters, numbers and special characters by repeatedly pressing the numeric buttons on the **FM2000** remote control handset, as when writing SMS news. The assignment of letters to the buttons is printed below the buttons. Special characters can be accessed using the **0** and **1** buttons:

| | |
|----------|------------------------------------|
| 0 | 0 + - * / ^ = { } () [] < > |
| 1 | . , ? ! : ; ' \ " ' _ @ \$ % & # ~ |

Use the blue **▲▼** button for toggling between numbers, capitals and lower-case letters. The bottom line of the screen shows which input mode is currently selected.

i At certain points (e.g. DNS server name) it is possible to enter both an alpha-numeric string and an IP address. At these points an IP address should be entered like a string (with separating dots as special characters). In this case an automatic check for valid address ranges (0 ... 255) is not carried out.

Closing the Menu

Once you have correctly set all the parameters, select the menu item **'Save and Restart'**, then press the **OK** button. This action causes the **MP 2000 R** to accept the settings, and the machine restarts with the new network settings. After the restart you should see the available network media sources (Internet radio, UPnP-AV server, etc.) displayed in the main menu.

Interrupting the Menu without Storing the Settings

At any time you can leave the network configuration menu without making any changes to the network settings: this is done by pressing the **■** button, which takes you to the menu item **'Exit without saving'**. Pressing the **OK** button at this juncture interrupts and closes the menu.

The Configuration for a Wired Ethernet LAN or Power-Line LAN connection

Setting the Parameters for a Wired Network

- Connect the **MP 2000 R** to an operational network or Power-Line modem using the LAN socket on the back panel.
- Switch the **MP 2000 R** on, and select the Streaming Client function by pressing the **SCL** button.
- Call up the Configuration menu as described above. You should now see the menu reproduced below, displaying the network parameters. In the title line the message 'LAN' should appear, indicating that the machine is connected to a wired LAN. If you see 'WLAN' at this point instead, please check your network connection, and ensure that the network is switched on and operational.
- You can now select the individual menu points and adjust them to match your network conditions. The illustration below shows the possible button inputs after each menu item.

| Network Parameter (LAN) | | Possible entries |
|-------------------------|-------------------|--------------------|
| MAC | 00:0e:9b:cc:a4:35 | none |
| → DHCP | Off | ◀ / ▶ |
| Device IP | 192.168.0.10 | (0 ... 9) |
| IP mask | 255.255.255.0 | (0 ... 9) |
| Gateway IP | 192.168.0.1 | (0 ... 9) |
| DNS 1 | 192.168.0.1 | (0 ... 9, A ... Z) |
| DNS 2 | 0.0.0.0 | (0 ... 9, A ... Z) |
| Proxy | XXX | ◀ / ▶ |
| Proxy IP | 192.168.0.1 | (0 ... 9, A ... Z) |
| Proxy port | 8080 | (0 ... 9) |
| Network IF Mode | Auto | ◀ / ▶ |
| Save and restart | Apply | OK |
| Exit without saving | Apply | OK |

- ◀ / ▶: Switching ON / OFF
- (0...9): Numeric input, separating dots are automatically generated; input limited to valid addresses
- (0...9, A...Z): Alpha-numeric input and special characters.
IP - separating dots must be entered as special characters.

i The parameters illustrated above are only typical values. Addresses and settings may require different values for your network.

| Menu Point | Description |
|----------------------------|---|
| MAC | The MAC address is a hardware address which uniquely identifies your machine. The address displayed is determined by the manufacturer, and cannot be altered. |
| DHCP | <p>ON If your network includes a DHCP server, please select the ON setting at this point. In this mode an IP address is automatically assigned to the <i>Cala</i> by the router. The screen shows only the MAC address and the message DHCP state ON. In this case the address input fields shown in the illustration do not appear in the menu.</p> <p>OFF If your network does not include a DHCP server, please select the OFF setting. In this mode you must configure the following network settings manually. Please ask your network administrator for the addresses to be entered for your network.</p> |
| Device IP | IP address of the <i>Cala</i> _____ |
| IP mask | Network mask _____ |
| Gateway IP | IP address of the router _____ |
| DNS 1 | Name / IP of the name server (optional) _____ |
| DNS 2 | Alternative name server (optional) _____ |
| Proxy state | ON if a proxy server is present, otherwise OFF _____ |
| Proxy IP | Address of the proxy server _____ |
| Proxy port | Port number of the proxy server _____ |
| Network IF Modus | Network setting: only WLAN, only LAN or automatic setting |
| | <p> The Network IF Mode 'auto' is the default factory setting. In case of problems in combination with your hardware this automatic function can be switched to a fixed operation mode, e.g. only LAN.</p> |
| Save and Restart | Stores the network parameters, and restarts the <i>Cala</i> with the new settings. _____ |
| Exit without saving | Closes the menu: data already entered is discarded. |

The Configuration for a WLAN connection

Setting the Parameters for a Radio Network

- Connect the WLAN aerial (supplied) to the **MP 2000 R** WLAN aerial socket, and ensure that no cable is attached to the **MP 2000 R** LAN socket.
- Switch the **MP 2000 R** on, and select the Streaming Client function by pressing the **SCL** button.
- Now call up the Configuration menu as described above: with a long press on the **SRC** button. You should now see the menu reproduced below, displaying the network parameters.

| Network Parameter (WLAN) | | Possible entries |
|--------------------------|-------------------|--------------------|
| MAC | 00:0e:9b:cc:a4:35 | |
| → WLAN configuration | start | none |
| DHCP | Off | ◀ / ▶ |
| Device IP | 192.168.0.10 | (0 ... 9) |
| IP mask | 255.255.255.0 | (0 ... 9) |
| Gateway IP | 192.168.0.1 | (0 ... 9) |
| DNS 1 | 192.168.0.1 | (0 ... 9, A ... Z) |
| DNS 2 | 0.0.0.0 | (0 ... 9, A ... Z) |
| Proxy | XXX | ◀ / ▶ |
| Proxy IP | 192.168.0.1 | (0 ... 9, A ... Z) |
| Proxy port | 8080 | (0 ... 9) |
| Network IF Mode | Auto | ◀ / ▶ |
| Save and restart | Apply | OK |
| Exit without saving | Apply | OK |

Searching for and Selecting the Network

First select the menu item **'WLAN configuration start'**, and activate it by pressing the **OK** button.

A menu appears showing these points:

- Rescan - initiates new search for accessible radio networks
- Set manually - adding a WLAN manually

After a brief delay the networks present in the vicinity are listed on the screen.

| List of WLANs |
|-------------------------|
| → Rescan |
| Set manually |
| XXXXX (name of network) |
| (1/3) |

You can use the 'Rescan' function to start a new search for networks present in the vicinity.

Please select one of the networks located, and activate it by pressing the **OK** button.

Entering the Password (for encoded networks)

| WLAN configuration | |
|--------------------|-------|
| → Passphrase | |
| Save WLAN settings | Apply |
| (1/2) | |

If your network is encoded, the window illustrated above now appears. Please enter the network password and confirm the entry by pressing **OK**. Now select the item 'Save WLAN settings' and confirm with **OK**.

i If a WEP code is used, the password must be entered as a hexadecimal code (0 - 9, A - F).

Please enter the settings for the remaining network parameters as described earlier in the section entitled **'Setting the Parameters for a Wired Network'**.

Storing Network Settings and Restarting

Finally select the menu item 'Save and Restart', and press the **OK** button; this action accepts the settings, and restarts the **MP 2000 R** with the new settings.

**Special case:
Manual Network Entry**

The **MP 2000 R** automatically searches for accessible radio networks, and lists them when you call up the menu item 'WLAN Configuration'. However, the **MP 2000 R** can only locate networks which broadcast their SSID network identity. For security reasons many radio networks do not transmit the SSID (if you are not sure about this, ask your network administrator). In such cases the network cannot be found and displayed automatically, i.e. it must be set up manually. This is the purpose of the menu item 'Set Manually'. If you select this menu item, you will see the input window reproduced below; you can enter the parameters for your network at this point.

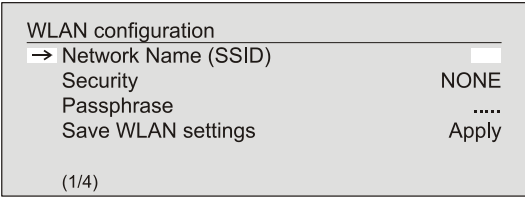

After successfully entering all the data, please select the item 'Save WLAN Settings', and confirm by pressing the **OK** button. Your **MP 2000 R** now accepts the data you have entered relating to the WLAN network, and moves on to the subordinate menu in which you can set the remaining network parameters, as described earlier in the section entitled '**Setting the Parameters for a Wired Network**'.

You can now leave the Configuration menu by selecting the menu item 'Save and restart'.

The vTuner Premium Service

The list of radio stations displayed by your **MP 2000 R** is prepared by an Internet Service Provider, and transferred to your machine by data transfer. You can expand and edit the 'Favourite Groups' and 'Added Stations' list to suit your preferences via the Internet portal of your service provider, using the main menu item 'Internet Radio'. This is the procedure:

Open your Internet browser and call up the following web address:
<http://ta.vtuner.com>

The first time you register you should enter the MAC address (ID#) of your **MP 2000 R**; the MAC address provides unique identification of your machine. The MAC address can be found in the Configuration menu (hold the **SRC** button pressed in, during Streaming Client operation), and consists of six pairs of characters, e.g.: 00:0e:9b:cc:a4:35. You do not need to enter the separating colons when you enter this data. MAC addresses are in hexadecimal format, i.e. the address consists only of the letters a to f, and the numbers 0 to 9.

Confirm your entry.

The screenshot shows the vTuner website interface. At the top, there are language selection flags and a 'Logout' link. The main header features the vTuner logo and a navigation menu with 'STATUS', '9754 Stations Available', '9649 Podcasts', and 'New Stations'. Below this, there are sections for 'My Favourite Groups' (with a 'Trance' link) and 'My Added Stations'. A table lists a station named 'Stellar Attraction' from 'Great Britain' with the genre 'Rock (Progressive, MP3 Rock)'. There is an 'Add Another Station' button and a search bar. Below the search bar, there are links to 'Browse Stations by Format', 'Browse Stations by Location', and 'Browse Stations by Language'. The 'Browse Stations by Format' section is expanded, showing a grid of categories such as Music, Talk, and various sub-genres like Adult Contemporary, Alternative, Ambient, etc., each with a count in parentheses.

You must register with vTuner in order to be able to use the service; you can register via your e-Mail address and a password. Please follow the instructions stated by the service provider.

Now you can select radio stations from the comprehensive inventory provided by vTuner, and store them in lists. The lists are transferred to your **MP 2000 R** automatically via your Internet connection. Shortly after you have edited lists on the vTuner page, or stored new stations, you will find that they are available on your **MP 2000 R**.

i Notes regarding Internet Radio:

- Not all stations are always accessible
 - Not all stations transmit 24 hours
 - Stations are no longer accessible
 - Capacity exhausted
- Transmission breaks off
 - (Internet) network problems
 - Server capacity exhausted

Setting up new Internet Radio Stations

On the vTuner Internet site you can also set up new stations which are not (yet) included in the Select lists. This is accomplished by registering with vTuner and logging on. Click on the item 'My Added Stations'. An input mask appears in which you can enter the data for your station. After a brief period you will be able to access the newly set-up station via the menu system of your **MP 2000 R**. You will find the station under Internet Radio / Added Stations.

Finding a Station URL



You require the URL (Internet address) of any radio station you wish to set up on the vTuner service. You will generally find the URL on the station's website. Another method of finding the URL is to search for it using an Internet searching service such as Shoutcast (www.shoutcast.com). Once you have found your station, click on the 'Tune In' switch: this will normally open your media player, and the station should play. In most cases you can set Media Player to display the 'Streaming Properties'. For example, using the popular Winamp Player, simply right-click on the entry for the currently playing station in the player's Playlist window. A menu now opens, and clicking on the item 'View File Info' opens an information box which displays the streaming properties including the URL.

FD 100 Radio Remote Control (optional)

The **MP 2000 R** can be controlled remotely using the **FD 100** bi-directional radio remote control handset if a Gateway module is installed; this is available as an optional extra. The **FD 100** features an integral full-colour screen which provides a convenient means of controlling virtually all the **MP 2000 R**'s functions, even when there is no direct line-of-sight contact with it. The handset can also display information relating to the selected source or the medium currently playing.

Connecting the radio aerial

Since the **FD 100** operates by a radio link, an aerial must be connected to the **MP 2000 R**. This is connected to the socket on the **MP 2000 R** marked 'Remote'. The aerial should be free-standing in order to obtain maximum effective range.

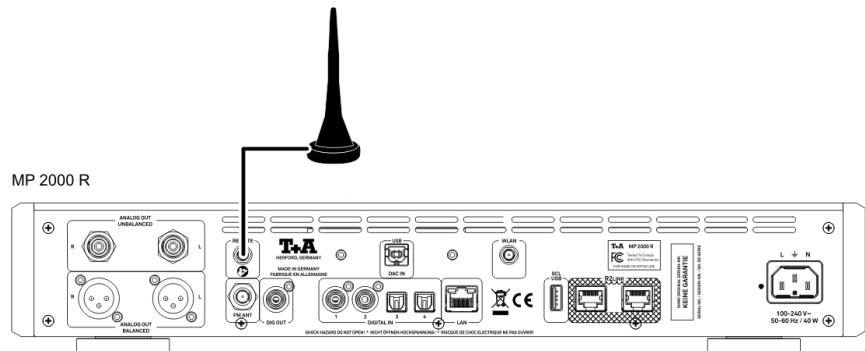

Pairing the FD 100

Before the **MP 2000 R** can be controlled using the **FD 100**, the remote control handset must first be registered to the **MP 2000 R**. This process is known as pairing, and only has to be carried out once. The procedure is as follows:

- Press the **MENU** button on the **MP 2000 R** to call up the Configuration menu.
- Rotate the **SELECT** knob on the front panel to select the "**FD 100 pairing**" menu item, and confirm your selection by pressing the **SELECT** knob.
- To confirm the pairing process of the **FD 100**, press the **SELECT** knob until the menu entry changes to 'waiting for FD 100'. (the function remains active for thirty seconds).
- Locate the **MENU** button on the **FD 100** and hold it pressed in to open the **FD 100**'s System Settings menu.
- Now select the 'Start pairing' point, and press the **OK** button: the remote control handset automatically seeks the **MP 2000 R**.
- Once the device is found, you will see in the display header the on-screen message 'Pairing successful'. At the same time changes the menu entry of the **MP 2000 R** to 'Done'. If you wish, you can change the name of the device at this point (eg. 'Living room' if more than one device is available).
- Confirm the name with the **OK** button.
- For faster access the **MP 2000 R** can also be assigned to a Hotkey; this is the next step (see **FD 100** operating instructions).
- Select one - or optionally none - of the 'F' buttons, and confirm your choice by pressing the **OK** button.
- The **FD 100** is now paired with the **MP 2000 R**, and is ready for use.



For detailed information on using the **FD 100** please refer to the operating instructions supplied with the remote control handset.

Firmware update

General information

For updating the firmware of the **MP 2000 R** there is a convenient method which requires an existing Internet connection. If the **MP 2000 R** is not connected to the Internet, an alternative method of updating the software is possible via the USB socket on the machine's front panel.

If you are operating the **MP 2000 R** in conjunction with a **PA 2x00 R**, the machine can also be updated via the **R2Link** connection.

The wiring diagram for the machine is shown in '**Appendix A**'.

The following section describes the exact method of updating the firmware in detail.

Updating via the Internet

Updating the firmware via the MP 2000 R's Internet connection

- The basic requirement is a functioning network with router and access to a broadband Internet connection; the system must be operating.
- Switch the machine on.
- Call up the System menu by pressing the **MENU** button on the front panel.
- Rotate the SELECT knob on the front panel to select the "**Device info**" menu point, and confirm your selection by pressing the SELECT knob.
- If the **MP 2000 R** is connected to a **PA 2x00 R** via the **R2Link** connection, the Select Device menu appears at this point. In this case select the device to be updated by turning the SELECT knob, then press the SELECT knob to confirm your choice.

(If the **MP 2000 R** is not connected to a **PA 2x00 R**, the Software Update menu of the **MP 2000 R** appears directly.)

- Select the "**Update**" menu point by rotating the SELECT knob, then press the SELECT knob to confirm your choice.
- The Select option "**USB**" should now be active (highlighted).
- Rotate the SELECT knob to change the set selection from "**USB**" to "**WEB**".
- The firmware update can now be started by pressing the SELECT knob.
- The screen displays the current state of progress of the update.
- Once the update has been completed (duration around ten minutes) the device automatically switches itself off and restarts.
- When the machine has restarted, the update is complete.
- To ensure that the update was successful, access the "**Device Info**" menu point mentioned above, and check the new firmware status.

i It is also possible to carry out the update process using the FM2000 remote control handset, as an alternative to operating the machine directly. The method of operating the menu using the handset is described in the chapter entitled "**Basic settings of the MP 2000 R**" (Using the remote control handset).

i As an option the update can be completed via a **LAN** or **WLAN** connection. Detailed information on setting up Internet access can be found in the chapter on page 42 entitled "**Network configuration**".

Updating via the USB socket

Updating the firmware via the USB socket of the MP 2000 R

You will need a USB memory stick (formatted using FAT 32) with more than 20 MB free memory space.

Preparing the USB stick

- Please download the latest firmware package for the **MP 2000 R** or **PA 2x00 R** (or for both if required) from the **T+A** website (www.ta-hifi.com).
- Unpack the compressed ZIP file(s) and copy the entire contents directly to your USB stick.
(please don't save the data in a sub-folder!)

Starting the update process

- Insert the prepared USB stick in the USB socket (USB IN) on the front panel of the **MP 2000 R**.
- Switch the machine on.
- Call up the System menu by pressing the **MENU** button on the front panel.
- Rotate the SELECT knob on the front panel to select the “**Device info**” menu point, and confirm your selection by pressing the SELECT knob.
- If the **MP 2000 R** is connected to a **PA 2x00 R** via the **R2Link** connection, the Select Device menu appears at this point. In this case select the device to be updated by turning the SELECT knob, then press the SELECT knob to confirm your choice.

(If the **MP 2000 R** is not connected to a **PA 2x00 R**, the Software Update menu of the **MP 2000 R** appears directly.)

- Select the “**Update**” menu point by rotating the SELECT knob, then press the SELECT knob to confirm your choice.
- The Select option “**USB**” should now be active (highlighted).
- The firmware update can now be started by pressing the SELECT knob.
- The screen displays the current state of progress of the update.
- Once the update has been completed (duration around ten minutes) the device automatically switches itself off and restarts.
- When the machine has restarted, the update is complete.
- To ensure that the update was successful, access the “**Device Info**” menu point mentioned above, and check the new firmware status.



It is also possible to carry out the update process using the FM2000 remote control handset, as an alternative to operating the machine directly. The method of operating the menu using the handset is described in the chapter entitled “**Basic settings of the MP 2000 R**” (Using the remote control handset).

Glossary / Supplementary Information

| | |
|---|--|
| CD | <p>Compact Discs (CD) are digital data media which need to be handled carefully. These are the basic rules:</p> <ul style="list-style-type: none">• The surface of a CD should only ever be cleaned with a soft dry cloth. Never wipe it in a circular motion, i. e. along the tracks.• Never use petrol, paint thinners, disc cleaners or similar materials on compact discs.• CDs must be handled carefully in order to avoid serious damage to the surface. Severely scratched surfaces, writing on the disc or applying self-adhesive labels may result in the CD player being unable to read the data.• CDs should not be heated or bent. This means that they should be stored in a position and attitude which meet these requirements. |
| R2 LINK | <p>Control interface for remote control of T+A systems.</p> |
| Field strength | <p>The electrical field strength is a measurement of the level (strength) of the radio signal supplied by the antenna. In general terms, the higher the field strength of the tuned station, the better the reception quality. Signal field strength is determined primarily by the following factors:</p> <ol style="list-style-type: none">1. Distance from radio transmitter2. Obstacles (mountains etc.) between transmitter and receiver3. Transmitter output power4. Quality and direction of the receiver antenna system. <p>Point 4 is of crucial importance here. It is impossible to obtain good reception with a poor aerial system.</p> <p>Your specialist T+A dealer will be glad to advise you on the subject of installing or improving your aerial system, taking your specific local reception conditions into account.</p> |
| FM = Frequency Modulation | <p>All FM radio transmitters use the 'FM' method of modulation. This technology provides maximum possible sound quality and interference suppression.</p> |
| Cable Network | <p>When the MP 3000 HV's tuner was being developed the requirements of the European cable network were given high priority. The tuner copes very well with excessive signal levels, and its high selectivity avoids many of the problems involved with cable operation, without any reduction in reproduction quality.</p> |
| MIX | <p>In MIX-Mode (Shuffle) the titles of a CD or the titles of a program are played back in a random order.</p> |
| Muting = Hiss suppression | <p>The MP 2000 R features automatic hiss suppression which cuts out the annoying hissing sound between radio stations, and suppresses very weak stations which cannot be received with reasonable quality.</p> |
| Preset = station memory | <p>The MP 2000 R can store all the settings for stations, any of which can be recalled simply by pressing a button.</p> |
| RDS = Radio Data System | <p>Many radio stations broadcast supplementary digital information simultaneously with the programme. The MP 2000 R is equipped with an RDS decoder, and displays the station name of RDS transmitters in plain text on its alpha-numeric screen. This is a great advantage when searching for particular stations.</p> |
|  RDS = Radio Data System | |
| SINGLE CD | <p>A Single CD' is a CD with smaller diameter and a shorter play time. The MP 2000 R can play back CD singles. Please insert these discs into the depression at the center of the disc tray.</p> |
| Standby | <p>The MP 2000 R can be switched on from the Standby state from the remote control handset.</p> |
| Seek threshold | <p>The seek threshold is the minimum field strength value at which the automatic station search process halts. It is set at a level which ignores very weak transmitters.</p> |

Technical description

Digital filters / Oversampling

Oversampling

The audio data on for example CDs is stored at a sampling rate of 44.1 - i. e. for each second of music 44.100 sampled values are available for each channel. In the **MP 2000 R** the audio data read from the CD is „multiplied“ to a higher sampling rate (352,8 kHz) before it is converted back into analogueue signal to the converter, which can then be converted with correspondingly higher precision. The raised sampling rate is a calculating process for which there are many different mathematical methods. In almost all digital audio devices which exploit the advantages of increased digital sampling rate a process known as a FIR filter is employed for this purpose. At **T+A** we have been carrying out research for more than ten years, aimed at improving the oversampling process, because the standard FIR method has one drawback to set against its indisputable advantages: it adds small pre- and post-echoes to the music signals. At **T+A** we have developed mathematical processes (known as Bezier polynomial interpolators) which do not share this disadvantage. For this reason they should sound better and more natural than the usual standard process. Since the calculating procedure employed by us is considerably more complex than the standard method, the **MP 2000 R** features a high-performance digital signal processor (DSP) which carries out the over-sampling process with immense precision (56 bit) using special algorithms developed by **T+A**.

The freely programmable DSP which we use is capable of carrying out the oversampling process using any method of calculation. For this reason we have implemented a slightly modified Bezier process (filters 3) in the **MP 2000 R** in addition to the pure Bezier process (filter 4), together with two variants of the standard process (filter 1 and filter 2). For more information on the different processes please refer to the next section. You can switch between the various algorithms, then decide for yourself which of the filters gives the results you prefer.

Oversampling 1 (Standard FIR Filter)

The long FIR filter is the standard oversampling process in digital technology, offering extremely linear frequency response, very high damping, linear phase characteristics and constant group delays. The disadvantage is the pre- and post-echoes which are added to the signal. These „time range errors“ tend to affect the music signal's dynamics, precision and naturalness, and reduce spatial orientation.

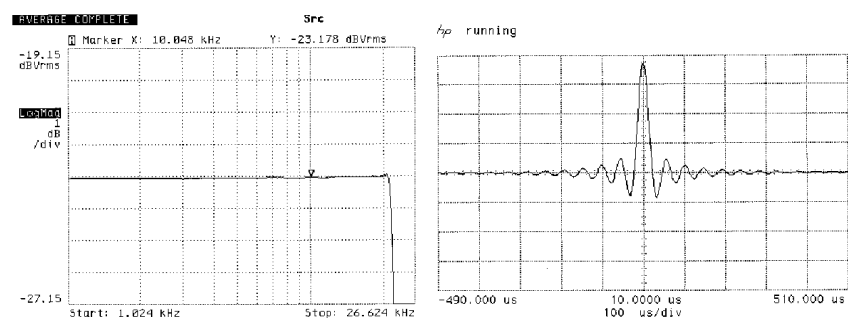

Frequency response and transient characteristics of the long FIR filter

Oversampling 2 (Impulse optimised filter)

Shortening the filter (lower coefficient) reduces the time range errors, albeit combined with a slight loss of linearity in the frequency range and damping performance.

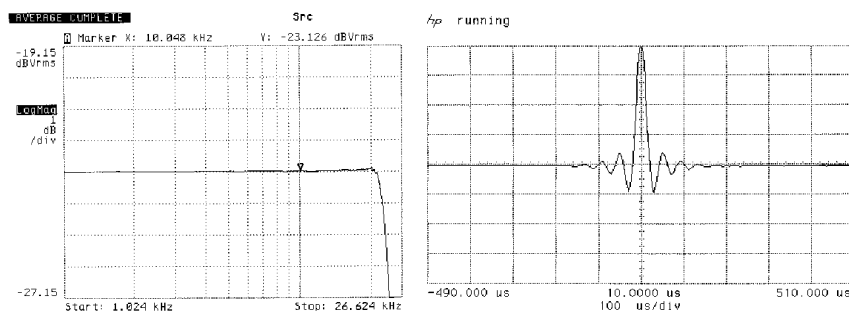

Frequency response and transient characteristics of the short FIR filter

Oversampling 3 (Bezier-interpolator plus IIR-filter)

In this process an ideal Bezier interpolator is combined with what is known as an IIR filter. This eliminates the problematic pre-echo of the FIR method. This process produces highly „analogueue“ system characteristics, with a sound quality and measured performance similar to those of good analogueue record players.

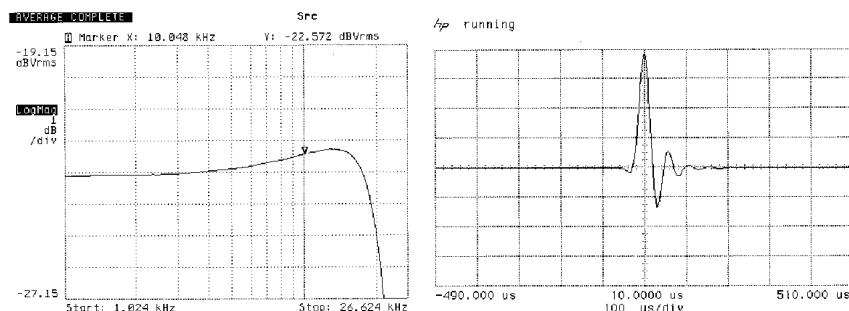

Frequency response and transient characteristics of the Bezier interpolator plus IIR filter

Oversampling 4 (pure Bezier interpolator)

This process delivers a perfect reconstruction of the original music signal. It exhibits no pre- or post-echoes of any kind, and does not add coloration or timing errors to the original signal. In sonic terms this method offers an impressive blend of naturalness, good dynamics and accuracy.

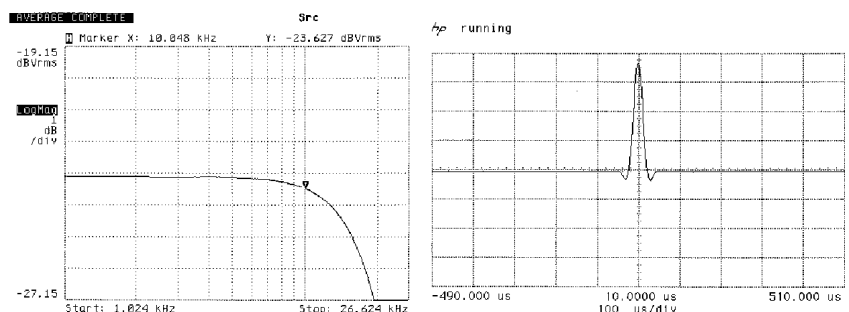

Frequency response and transient characteristics of the Bezier interpolator

Network Terminology

General information

The Switch ensures that the individual components within a network are connected correctly. This is only possible if it can identify each device within the network unambiguously; this is the reason why every component is assigned a form of "house number" (IP address). The IP address consists of four number blocks each containing three digits separated by dots (e.g. 192.168.1.1).

Each of the individual number blocks may contain values between 1 and 254 (the values 0 and 255 are reserved for certain special functions, and should therefore not be used). However, if the network is to operate reliably, the network owner should only select addresses designed for home network use - i.e.: the first two number blocks should always be 192.168.xxx.xxx; the third block can be selected without restriction within the above limits (but should be the same for all devices on the network), and the fourth block must distinguish each device uniquely (e.g.: **MP 2000 R** 192.168.001.001, **NAS**: 192.186.001.002, **PC**: 192.168.001.003, ...).

If this local network is to include Internet music sources (Internet radio) as well as physical devices, then the **T+A MP 2000 R** must have access to the Internet. This facility is provided by a device such as a router with connection to the DSL network. This router is also a constituent part of the network, and is assigned its own IP address. The **T+A MP 2000 R** must also be informed of the address of the router (Gateway) to enable it to gain access to the outside world.



Please ensure that the first three blocks of the Device IP, Gateway IP and DNS 1 share the same address space (e.g. 192.168.0.xxx). The fourth block assigns a unique address (house number) to the components in the local network. This number must not be present more than once in the local network. The Device IP mask should always be assigned the address 255.255.255.0.

DNS

The Domain Name System (DNS) is one of the most important services on the Internet. Its primary task is to convert "Internet addresses", such as www.taelektroakustik.de, into the associated IP address. In most home networks the router carries out the DNS function.

If you decide to configure your network manually (without DHCP), then simply enter the address of your router as the DNS address when configuring the network.

Ethernet-LAN

Wired network. Interference-free network technology, with the drawback of having to deploy a network cable.

Gateway

The computer or router in your network which is responsible for managing data traffic between your home network and the outside world (i.e. the Internet).

Client

Network device which obtains data from the network, decodes it and converts it into, for example, analogue music signals which can then be reproduced via an amplifier and loudspeakers. Streaming Clients also contain functions for displaying media content, and for navigating on the Internet or servers.

DHCP

DHCP is an abbreviation of **D**ynamic **H**ost **C**onfiguration **P**rotocol. The primary purpose of DHCP is to enable Clients to obtain your network configuration automatically from a server or router.

IP-Adress

Network address. Each device in the network requires an IP address at which it can be accessed, and by which it is unambiguously identifiable. No individual network address may be present more than once. This is important if you are entering network addresses manually. If the addresses in your network are assigned by DHCP, you do not need to worry about IP addresses at all, as the DHCP server manages the addresses automatically without your intervention.

| | |
|---|--|
| NAS (Network Attached Storage) | Network storage facility. This is generally a very large-capacity (> 200 GB) storage device to which other devices have access. If the NAS server includes a UPnP-AV server service, then the MP 2000 R has access to media files stored on the NAS, and can play them back. |
| Powerline-LAN | In a Power-Line LAN data is transferred via the existing mains power cabling. Devices known as "Power-Line modems" are required at the transmitting and receiving end. In most cases Power-Line offers relatively problem-free data transfer with adequate data rates for audio streaming. We recommend Power-Line modems with bit rates of 85 or 200 Mbit/s. |
| Proxy server | A Proxy or Proxy server is a computer in the network which is capable of carrying out data transfers faster and more efficiently, and can increase security through the use of access control mechanisms. Most home networks do not include a proxy server. In this case there is no need to enter a Proxy address when configuring the MP 2000 R network. |
| Router | Central network device which creates and manages the connections between the network devices. In most networks the router also assumes the function of Gateway to the outside world. |
| Server | Network device which provides data and services for other devices in the network. For example, a UPnP-AV server typically stores audio / video data, and makes it available to other devices (the Streaming Clients). Many UPnP-AV servers also offer functions such as cataloguing, and easy identification of media content using criteria such as artiste, album name, genre, etc. |
| UPnP-AV | <p>Network protocol that makes media files available on the home network.</p> <p>On PCs and NAS storage devices a UPnP-AV server software must be installed to enable the MP 2000 R to access media files stored on these devices.</p> <p>Examples for UPnP-AV server software compatible with the MP 2000 R:</p> <p>Windows:</p> <ul style="list-style-type: none"> • Twonky Media Server http://www.twonkyvision.de/ • Windows Media Player 11 http://www.microsoft.com/windows/windowsmedia/de/default.aspx <p>Linux:</p> <ul style="list-style-type: none"> • Mediatomb http://mediatomb.cc/ • GmediaServer http://www.gnu.org/software/gmediaserver/ |
| WLAN (also W-LAN, Wireless LAN) | Radio network. The network is connected by means of radio waves operating in the 2.4 GHz frequency band. Radio networks are easy to install as no cables have to be deployed, but they are often problematic and unreliable - especially when the transmission distances are substantial. Power-Line networks, which can also be installed without separate cabling, are a better choice in many situations. In every case the deployment of a network cable is the most reliable and problem-free technology for data transfer. |
| Compatible hardware and UPnP servers | The marketplace offers a vast number of routers, NAS devices and USB hard discs made by a very wide range of manufacturers. T+A equipment is generally compatible with other makes of machine which bear the UPnP label. A list of devices which T+A has checked for compatibility can be found on the Internet at: http://www.ta-hifi.de/fileadmin/software/e-serie/MP_HW_KOMP.pdf |

Trouble shooting

Many problems have a simple cause and a correspondingly simple solution. The following section describes a few difficulties you may encounter, and the measures you need to take to cure them. If you find it impossible to solve a problem with the help of these notes please disconnect the unit from the mains and ask your authorised **T+A** specialist dealer for advice.

Machine does not switch on (Display does not light up).

Cause 1:
Mains leads not plugged in correctly.
Remedy:
Check connection, push connector in firmly.

Tuner

Whistling or whispering noises from the speakers.

Cause:
The antenna lead is routed too close to a mains, remote control or audio signal cable.
Remedy:
Move the leads so that they are spaced well apart. Use the domestic (loft or outside) antenna or a cable connection.

The RDS station name does not appear in the display.

Cause 1:
The station is not broadcasting **RDS** information.
Cause 2:
Reception is poor, interference is severe, or the *field strength* (signal strength) is low.
Remedy:
Select only those stations which can be received with a strong signal: hiss-free and without interference.

The unit can be operated normally, but very few stations or none at all can be picked up.

Cause:
The antenna system or antenna cable is faulty.
Remedy:
Check the antenna lead for good contact at the antenna socket (at the wall) and in the back of the tuner. As a test, try using the system with a trailing antenna. If you can now receive stations reasonably well, we recommend that you call out an expert antenna technician to check your antenna system.

CD player

The screen displays the message 'No Disc' when you close the CD drawer.

Cause 1:
CD not inserted correctly.

Remedy:
Place CD centrally in the drawer, printed face up.

Cause 2:
CD dirty.

Remedy:
Clean disc and insert again.

Cause 3:
CD damaged in the Table of Contents (TOC) area.

Remedy:
No remedy; the CD is unusable.

Cause 4:
The CD player has become very cold (e. g. in transit) and condensation has formed on the laser sensor optics.

Remedy:
Allow the unit to warm up for about an hour in a warm, well ventilated location.

CD playback stops or 'jumps'.

Cause 1:
CD damaged or dirty.

Remedy:
Clean CD. A damaged CD cannot be repaired!

Cause 2:
The CD uses a copy protection system which does not conform to the CD-Audio standard (Red Book Standard)

Remedy:
Take back the CD to the dealer and ask for a proper CD according to the general CD standard.

Loud humming noise from the loudspeakers.

Cause:
Poor contact between the Cinch plugs and sockets, or a faulty Cinch cable.

Remedy:
Please check all connections and cables thoroughly.

Disc drawer does not open.

Cause:
Mechanical blockage, jammed disc, faulty disc mechanism.

Remedy:
Open the disc drawer manually.
First switch the machine off (disconnect the mains plug). You will find an opening in the bottom through which you can disengage the disc drawer by pushing the white disengagement slider fully to the left using a suitable screwdriver. This will cause the drawer to open by a few millimetres, and you can then extend it fully by hand.

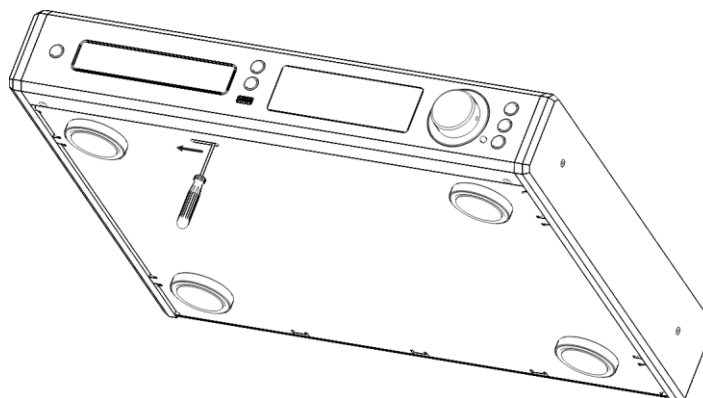

Streaming Client

The streaming client cannot connect to a network.

On the display the indication 'SCL Connecting...' is displayed.

Cause 1 (cable LAN):

Network cable not properly connected

Remedy:

Connect network cable, check connection to router

Cause 2 (wireless LAN):

WLAN antenna not connected or placed in a location with bad reception quality

Remedy:

Connect WLAN antenna properly and find a location with good reception quality.

Set the transmission power output of your WLAN router to maximum.

Try to establish a network connection first in a location close to the WLAN router. If this succeeded try to connect to WLAN from a more remote location. Experiment with antenna position and try to find a location with better reception quality.

Cause 3 (wireless LAN):

WLAN reception quality bad (low field strength). Possibly too much attenuated by walls/ceilings on the transmission path.

Remedy:

Optimize location of receiver and transmitter antennas.

Alternative:

If transmission problems persist a so called 'Power Line' network might be good alternative to establish a good and stable network connection.

The best, safest and most secure network however will always be a cable LAN network.

Cause 4:

Network parameters not properly configured.

Remedy:

Configure the network parameters correctly (see chapter '**Network configuration**').

Cause 5 (operation without network connection):

For proper operation the **MP 2000 R** needs at least one properly connected network device. This can be a LAN or WLAN network or a USB storage device.

Remedy:

If the **MP 2000 R** shall be operated without network (LAN / WLAN) please connect at least a USB stick.

The message

'Track not found' is displayed

Cause:

The music file on the storage device or on the music server was deleted or the internet radio station is not available at the moment.

Remedy:

Choose another music title or radio station. If the station or title is not available any more it should be deleted from the Favourites List (if stored there).

The message

'Format Error' is displayed

Cause:

The title is stored / the radio station is transmitting in a format that cannot be decoded by the **MP 2000 R**.

Remedy:

Choose another title or station.

The message

'network problems – restarting' is displayed

Cause:

Network problems in your home network or on the internet occurred; the connection was interrupted.

Remedy:

When encountering a network problem or interruption the **MP 2000 R** will re-start the network communication. After re-start please choose a music title or internet radio station and start playback.

| | |
|--|---|
| <p>Transmission interruptions occur when listening to internet radio stations.</p> | <p>Cause 1: The capacity of the internet radio station's server is at its limit.</p> <p>Remedy: Choose a different station.</p> |
| | <p>Cause 2: Network problems occurred.</p> <p>Remedy: Check your network (see above).</p> |
| <p>Some internet radio stations cannot be received</p> | <p>Cause: The internet radio station has been switched off, it transmits only at certain hours of the day or it has changed its internet address.</p> <p>Remedy: Try to get information from the website of the station regarding transmission hours and internet address (URL). Try to establish a connection to the station at a later time.</p> |
| <p>Bad sound quality at certain internet radio stations</p> | <p>Cause: The station transmits with a low audio bandwidth (low bitrate).</p> <p>Remedy: Use stations transmitting at least at 128 kBit/s. This is the lowest recommended bitrate for adequate sound quality. For good sound quality we recommend high bitrates like 320 kBit/s</p> |
| <p>USB Storage device is not recognised</p> | <p>Cause 1: The storage device (especially USB hard discs without separate power supply) draws more electrical current from the USB interface than is permitted by the USB standard.</p> <p>Remedy: Only use USB storage devices that conform to the USB standard or use storage devices with own power supplies.</p> <p>Cause 2: The storage device is not formatted with an appropriate file system.</p> <p>Remedy: The MP 2000 R accepts storage devices with FAT16 or FAT32 file systems.</p> <p>Note: For big music archives we recommend to use a NAS (network attached storage) device with a UPnP-AV server to which the MP 2000 R will connect via your home network.</p> |
| <p>Problems occur with high-resolution audio formats (HD audio) (FLAC and WAV).</p> | <p>Cause: The MP 2000 R is receiving audio data via a WLAN connection. WLAN connections do not provide reliable quality, and in most cases are not adequate for HD audio.</p> <p>Remedy: If you want to play back HD audio formats via a network connection, please use a LAN cable network.</p> |

Appendix A

Wiring diagram

balanced (XLR)

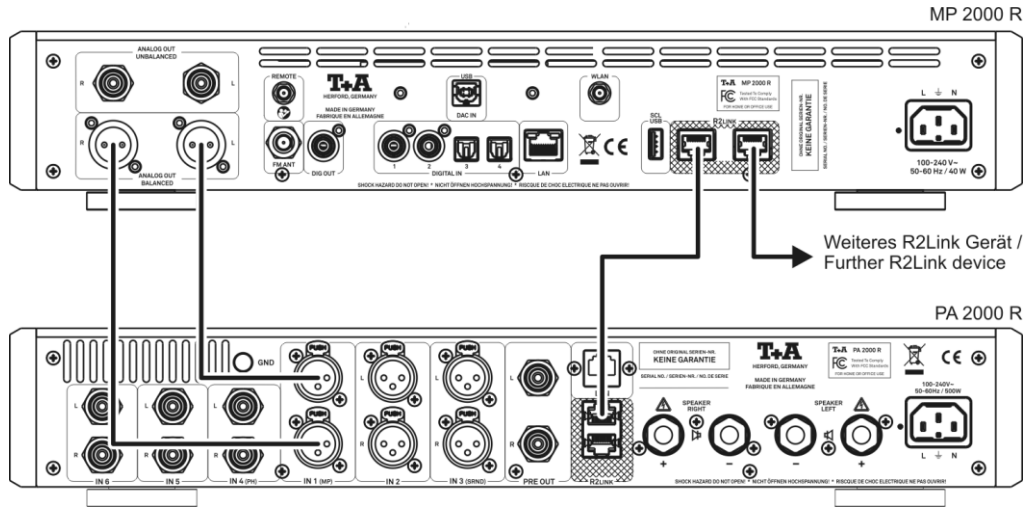

unbalanced (Cinch / RCA)

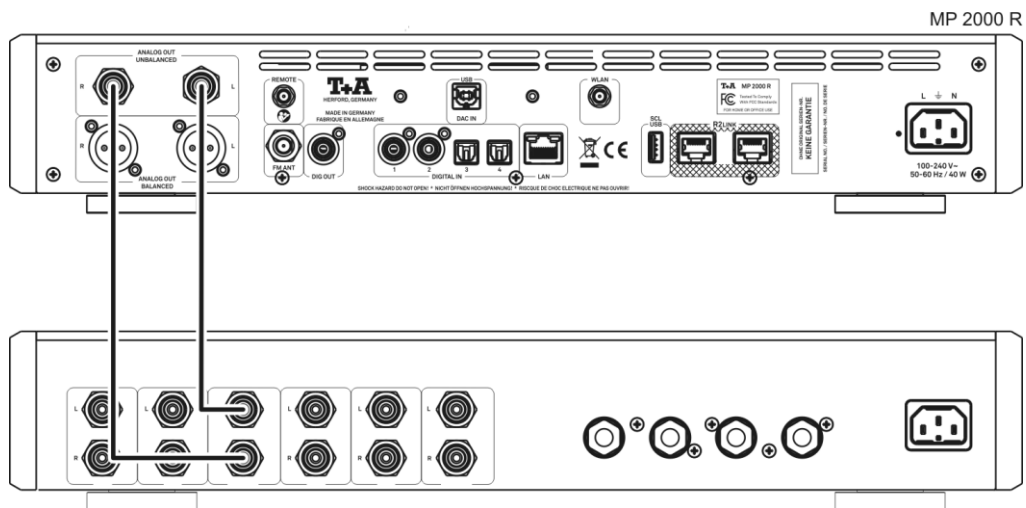

Wiring diagram

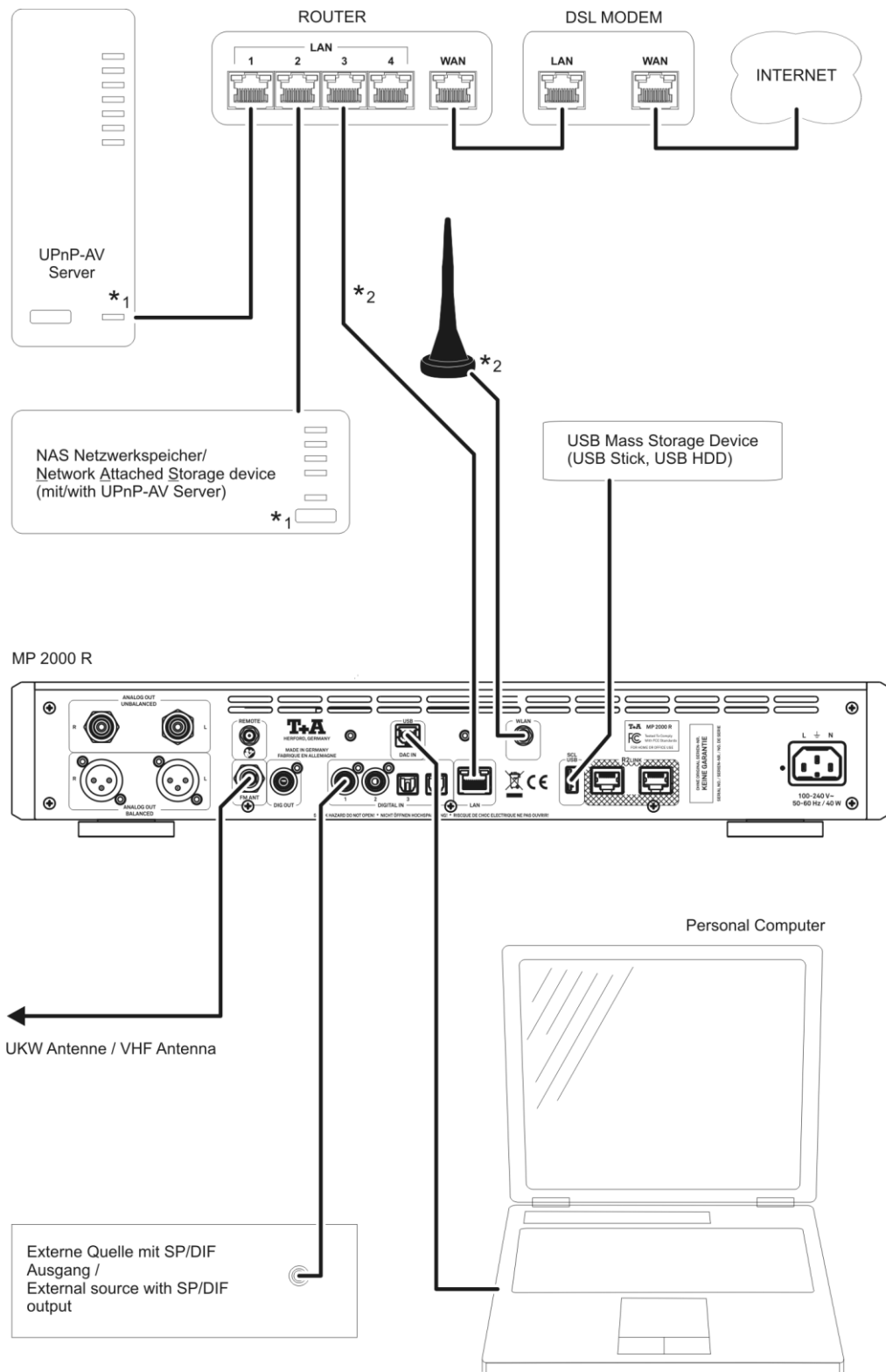

Attention!

A properly set up home network with router must be installed and in operation to use the **MP 2000 R**.

For the use of internet radio a DSL access to the internet is needed.

For questions regarding setting up your network and internet connection please ask your system administrator or any network specialist.

*1 Music Server with UPnP-AV server software installed

*2 Connection either via Cable-LAN or Wireless-LAN

Appendix B

Specification

CD-Player

| | |
|--------------------------------|-----------------------------|
| Formats | CD/DA, CD-R, CD-RW, CD-Text |
| Frequency response and dynamic | 2 Hz – 20 kHz / 100 dB |

Streaming Client

| | |
|------------------------|---|
| Formats | MP3, WMA, AAC, FLAC, OGG-Vorbis, FLAC (192 / 32 over LAN) and WAV (192 / 32 over LAN), AIFF (192 / 32 over LAN), ALAC (96/24 over LAN) |
| Supported Media server | UPnP 1.1, UPnP-AV and DLNA compatible Server, Microsoft Windows Media Connect Server (WMDRM10), vTuner Internet Radio Service, DLNA compatible Server |
| Features | Auto Network Config., Internet Radio Station database (automatic updates) |

Tuner (FM)

| | |
|---------------------------|---|
| Frequency range | FM Radio 87,5 – 108 MHz (Europa / US) 76 – 90 MHz (Japan Version)) |
| Sensitivity | Mono (26dB S/N) 0,9 μ V, Stereo (46 dB S/N) 40 μ V |
| Overload margin | 103 dB μ V, |
| Stereo channel separation | 50dB |
| RDS functions | Stationname, Radiotext |

Tuner (DAB)

| | |
|----------------------------|--------------------------|
| Reception standard | DAB, DAB+ |
| Frequency range | 168 – 240 MHz (Band III) |
| Overload margin | 103 dB μ V, |
| Sensitivity (BER = 10 – 4) | 2,5 μ V |

Bluetooth

| | |
|--|---|
| | aptX® Bluetooth Audio transmission protocol |
|--|---|

Connections

| | |
|---------------------------|---|
| Analogue outputs | |
| asymmetric co-axial (RCA) | 2,2 V_{eff} / 50 Ohm |
| symmetric (XLR) | 4,4 V_{eff} / 50 Ohm |
| Output digital | 1x coax, IEC 60958 (LPCM) |
| Digital inputs | 4x S/P-DIF: 2x standard coax (192 kSps /24 bit) and 2x optical TOS-Link (96 kSps /24 bit) 1x USB: Device-Mode - up to 384 kSps / 32 bit (LPCM) and DSD256*, supports asynchronous data transfer. 2x USB master-mode for USB-mass storage devices (USB stick or VFAT formatted harddisc) * DSD256 only with a Windows PC with appropriate driver installed. |

D/A-Converter

| | | |
|-----------------------------------|--|------------------------|
| | Double-Differential-Quadruple-Converter with 4 D/A converters per channel, 32-Bit Sigma Delta, 352,8 kSps / 384 kSps. | |
| Upsampling | Programmable Digital Signal Processor with 4 selectable oversampling algorithms: FIR short, FIR long, Bezier/IIR, Bezier | |
| Analogueue filter | Phase-linear Bessel filter 3 rd order, switchable 60...120 kHz (according to sample rate) | |
| Frequency response | PCM 44.1 kSps: 2 Hz - 20 kHz | |
| | PCM 48 kSps: 2 Hz - 22 kHz | DSD 64: 2 Hz - 44 kHz |
| | PCM 96 kSps: 2 Hz - 40 kHz | DSD 128: 2 Hz - 60 kHz |
| | PCM 192 kSps: 2 Hz - 80 kHz | DSD 256: 2 Hz - 80 kHz |
| | PCM 384 kSps: 2 Hz - 100 kHz | |
| Total harm. distortion | < 0.001 % | |
| Signal : noise ratio, A-weighted: | 110 dB | |
| Channel separation | 110 dB | |

Power requirement

| | | |
|-------------------|------------------------------|--|
| | 100 - 240 V~ , 50-60 Hz | |
| Power consumption | max. 40 W Standby < 0,5 W | |

Dimensions

| | | |
|--|------------------------------|--|
| | 8,2 x 46 x 40 cm (H x W x D) | |
|--|------------------------------|--|

Accessory

| | | |
|--|---|--|
| | Infrared remote control FM2000, W-LAN aerial, FM aerial, aerial adaptor, RCA cord, XLR cord, power cord, R2-Link-Cable, user manual | |
|--|---|--|

We reserve the right to alter specifications

T+A elektroakustik GmbH & Co. KG

Herford

Deutschland * Germany