

# R 2500 R

## User manual

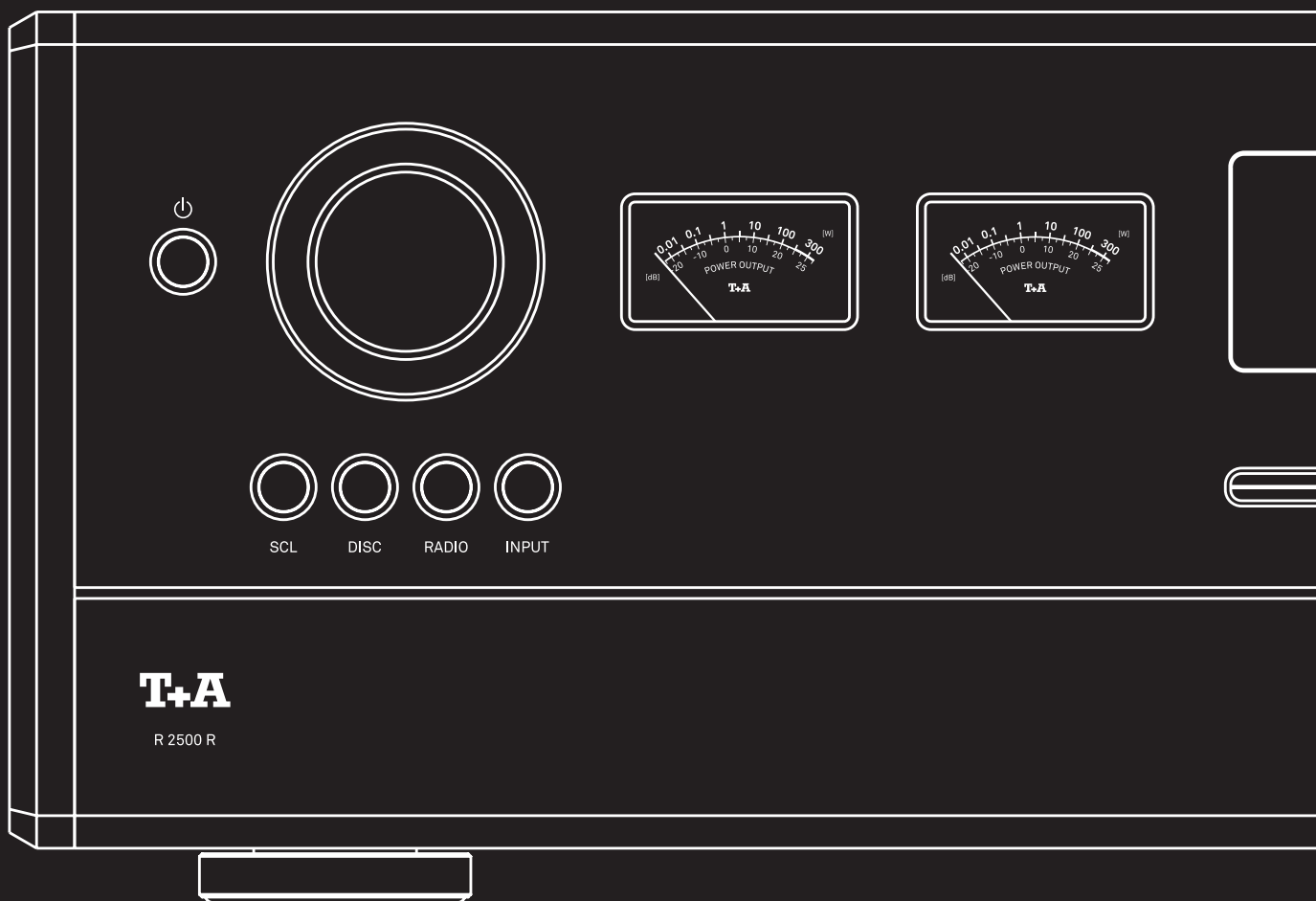

## Welcome

We are delighted that you have decided to purchase a T+A product. Your new Multi-Source-Receiver is a Hi-Fi unit of the highest quality, designed and developed with a single aim as top priority: to satisfy the requirements of the audiophile music lover.

This unit is the embodiment of innovative thinking and solid quality, exploiting the finest materials and components available, and all these factors contribute to a machine which will satisfy your most stringent demands and your most searching requirements for a period of many years.

Our production areas are supervised by highly qualified expert staff, and all final production units are checked comprehensively by a fully automated, computer-controlled system to ensure uniformly high quality. We guarantee that our products meet our own specifications to the full.

At all stages of production we avoid the use of substances which are environmentally unsound or po-

tentially hazardous to health, such as chlorine-based cleaning agents and CFCs.

We also aim to avoid the use of plastics in general, and PVC in particular, in the design of our products. Instead we rely upon metals and other non-hazardous materials; metal components are ideal for recycling, and also provide effective electrical screening.

Our robust all-metal cases exclude any possibility of external sources of interference affecting the quality of reproduction. From the opposite point of view our products' electro-magnetic radiation (electro-smog) is reduced to an absolute minimum by the outstandingly effective screening provided by the metal case.

We would like to take this opportunity to thank you for the faith you have shown in our company by purchasing this product, and wish you many hours of enjoyment and sheer listening pleasure with your R 2500 R.

# Content

|   |           |
|---|-----------|
| <b>Notes</b>                              | <b>6</b>  |
| <b>Safety notes</b>                       | <b>8</b>  |
| <b>Connections</b>                        | <b>10</b> |
| ANALOG INPUTS / OUTPUT                    | 10        |
| ANALOG IN                                 | 10        |
| ANALOG OUT                                | 10        |
| CONTROL                                   | 10        |
| R2LINK                                    | 10        |
| USB STORAGE MEDIA                         | 10        |
| NETWORK CONNECTION                        | 11        |
| USB AUDIO INPUT                           | 11        |
| DIGITAL INPUTS / OUTPUT                   | 11        |
| HDMI INPUTS                               | 11        |
| RADIO ANTENNA                             | 11        |
| LOUDSPEAKER                               | 11        |
| POWER SUPPLY                              | 11        |
| <b>Installation and connection</b>        | <b>12</b> |
| Installation                              | 12        |
| Connection                                | 12        |
| Connection of source devices              | 13        |
| Connection of loudspeakers                | 14        |
| Connection of turntable G 2000 R          | 15        |
| <b>Controls and functions</b>             | <b>16</b> |
| On- / Off switch                          | 16        |
| Navigation and control / Source selection | 16        |
| Level meter                               | 16        |
| Display                                   | 17        |
| Volume control                            | 17        |
| Disc drive mechanism                      | 17        |
| Headphones and USB Front sockets          | 17        |
| Outputs                                   | 17        |
| Tone and system settings                  | 17        |
| <b>Remote control</b>                     | <b>18</b> |
| On / off switch                           | 18        |
| Source selection                          | 18        |
| Muting                                    | 18        |
| Volume control                            | 18        |
| Alpha-numeric entry                       | 19        |
| Navigation                                | 19        |
| Playback functions                        | 19        |
| System and tone configuration             | 19        |
| Function buttons                          | 20        |
| Range                                     | 20        |
| Replacing the battery                     | 20        |
| Important information                     | 21        |

|  |           |
|--|-----------|
| <b>T+A Music Navigator App</b>               | <b>21</b> |
| Download                                     | 21        |
| <b>Configuration</b>                         | <b>22</b> |
| Menu / Tone operation                        | 22        |
| System configuration                         | 23        |
| Tone configuration and converter settings    | 25        |
| <b>Network configuration</b>                 | <b>27</b> |
| General information                          | 27        |
| Menu operation                               | 27        |
| Connection via LAN (cable connection)        | 27        |
| Connecting to WLAN (radio connection)        | 28        |
| Configuration using the WPS function         | 29        |
| <b>SCL Streaming Client operation</b>        | <b>30</b> |
| General information                          | 30        |
| Source selection                             | 30        |
| Local Musicserver (UPnP/DLNA compatible NAS) | 30        |
| Streaming Services of the Streaming Client   | 30        |
| Spotify Connect                              | 30        |
| Apple Airplay                                | 31        |
| Tidal Connect                                | 31        |
| Roon Operation                               | 31        |
| <b>CD player operation</b>                   | <b>32</b> |
| Source selection                             | 32        |
| Insert and eject a disc                      | 32        |
| Playback mode                                | 32        |
| <b>Radio operation</b>                       | <b>33</b> |
| General information                          | 33        |
| DAB Radio                                    | 35        |
| Internet Radio                               | 36        |
| <b>Presets list</b>                          | <b>37</b> |
| General information                          | 37        |
| Calling up the presets list                  | 37        |
| Adding a preset                              | 37        |
| Erasing an item from the Presets list        | 37        |
| Play Presets                                 | 38        |
| Sort Presets                                 | 38        |
| <b>Input operation</b>                       | <b>39</b> |
| General information                          | 39        |
| D/A Converter Operation                      | 39        |
| Source selection                             | 39        |
| USB Media                                    | 39        |
| Bluetooth                                    | 39        |
| HDMI   | 40        |
| Digital IN 1 ... IN 3 (S/P-DIF)              | 40        |
| USB DAC Playback from a computer             | 41        |
| Analog IN 1 ... IN 3                         | 41        |
| <b>Hotkeys</b>                               | <b>41</b> |

|                               |           |
|-------------------------------|-----------|
| <b>HDMI connection</b>        | <b>42</b> |
| <b>Protection</b>             | <b>43</b> |
| <b>Firmware update</b>        | <b>44</b> |
| General information           | 44        |
| Update procedure              | 44        |
| <b>Troubleshooting</b>        | <b>45</b> |
| <b>Notes on energy saving</b> | <b>47</b> |
| General information           | 47        |
| Automatic power down function | 47        |
| <b>Legal Information</b>      | <b>47</b> |
| General information           | 47        |
| Show licenses                 | 47        |
| <b>Specifications</b>         | <b>48</b> |
|                               | <b>48</b> |

# Notes

## User manual

---



**Text passages marked with this symbol contain important information which must be observed if the machine is to operate safely and without problems.**

---



*This symbol marks text passages which provide supplementary notes and background information; they are intended to help the user understand how to get the best out of the machine.*

---

## Symbols and notes on the back of the R 2500 R

---



This symbol marks alternating voltages (AC).  
The AC voltage required for the device can be found on the printing at the mains input socket. Do not connect the device to other power supplies.

---



This symbol marks the protective earth connector (ground connection).  
The unit is designed for operation at a protective earth conductor socket.

---



The device is designed to operate in altitudes up to 2000 m above sea level.

---



The device is designed to operate in a temperate climate.  
The range of permissible operating temperatures is +10 ... +35°C.

---



The only permissible method of disposing of this product is to take it to your local collection centre for electrical waste.

---



All the components we use meet the German and European safety norms and standards which are currently valid. This product complies with the EU directives. The declaration of conformity can be downloaded from [www.ta-hifi.com/DoC](http://www.ta-hifi.com/DoC).

---



T+A declares conformity with the directives of the United Kingdom and the national laws derived from them by means of the symbol located on the device. The declaration of conformity can be viewed at [www.ta-hifi.com/DoC](http://www.ta-hifi.com/DoC) if required.

---



Attention! Please refer to the important safety information in this manual.

---

## License notices

---



The Spotify Software is subject to third party licenses found here:  
[www.spotify.com/connect/third-party-licenses](http://www.spotify.com/connect/third-party-licenses).

---



Use of the Works with Apple AirPlay badge means that an accessory has been designed to work specifically with the technology identified in the badge and has been certified by the developer to meet Apple performance standards. Apple and AirPlay are trademarks of Apple Inc., registered in the U.S. and other countries and regions.

---



Qualcomm is a trademark of Qualcomm Incorporated, registered in the United States and other countries, used with permission. aptX is a trademark of Qualcomm Technologies International, Ltd., registered in the United States and other countries, used with permission.

---



The Bluetooth® word mark and logos are registered trademarks owned by Bluetooth SIG, Inc. and any use of such marks by T+A elektroakustik is under license. Other trademarks and trade names are those of their respective owners.

---



HD Radio Technology manufactured under license from iBiquity Digital Corporation. U.S. and Foreign Patents. HD Radio™ and the HD, HD Radio, and “Arc” logos are proprietary trademarks of iBiquity Digital Corp

---

This product contains software in form of object code that is partially based on free software under different licenses, especially the GNU General Public License. You can find details on this in the License Information which you should have received with this product.

If you have not received a copy of the GNU General Public License, please see <http://www.gnu.org/licenses/>.

For a period of three years after last distribution of this product or its firmware, T+A offer the right to any third party to obtain a complete machine-readable copy of the corresponding source code on physical storage medium (DVD-ROM or USB stick) for a charge of 20€. To obtain such copy of the source code, please write to the following address including information about product model and firmware version: T+A elektroakustik, Planckstr. 9-11, 32052 Herford, Germany.

The GPL license and further information about Licenses can be found on the internet under this link:

<https://www.ta-hifi.de/support/licence-information-CARUSO/>

---



# Safety notes

For your own safety please consider it essential to read these operating instructions right through, and observe in particular the notes regarding setting up, operation and safety.

---

The operation instructions, the connection guidance and the safety notes are for your own good - please read them carefully and observe them at all times. The operating instructions are an integral part of this device. If you ever transfer the product to a new owner please be sure to pass them on to the purchaser to guard against incorrect operation and possible hazards.

---

The device is intended to be connected to mains outlets with protective earth connector. Please connect it only with the mains cable supplied to properly installed mains outlets with protective earth connector. The power supply required for this unit is printed on the mains supply socket. The unit must never be connected to a power supply which does not meet these specifications.

---

This device is connected to the power supply as long as the power cord is connected. Even if the device is switched off and the status indicators are dark, the device still carries mains voltage inside. To disconnect the device completely from mains power supply, the mains plugs must be withdrawn from the wall socket. Please make sure that the mains plugs are easily accessible. Even when the unit is in standby mode, it has a low power consumption. If the unit is not to be used for a long period disconnect it from the mains supply at the wall socket.

---



The device is designed to operate in a temperate climate and altitudes up to 2000 m above sea level. The range of permissible operating temperatures is +10 ... +35°C.



This device is designed exclusively for reproducing sound and/or pictures in the domestic environment. It is to be used in a dry indoor room which meets all the recommendations stated in these instructions.

Where the equipment is to be used for other purposes, especially in the medical field or any field in which safety is an issue, it is essential to establish the unit's suitability for this purpose with the manufacturer, and to obtain prior written approval for this usage.

---

If the unit gets very cold (e. g. when being transported), condensation may form inside it. Please do not switch it on until it has had plenty of time to warm up to room temperature, so that any condensation evaporates completely.

---

---

Before placing the unit on sensitive lacquer or wood surfaces please check the compatibility of the surface and the unit's feet on a non-visible point and if necessary use an underlay. We recommend a surface of stone, glass, metal or the like.

---

Please consider the weight of the device. Never place the device on an unstable surface; the machine could fall off, causing serious or even fatal injury. Many injuries, especially to children, can be avoided if the following simple safety precautions are observed:

- Use only such items of furniture which can safely bear the weight of the device.
- Ensure that the device does not project beyond the edges of the supporting furniture.
- Do not place the device on tall furniture (e.g. bookshelves) without securely anchoring both items, i.e. furniture and device.
- Explain to children the hazards involved in climbing on furniture to reach the device or its controls.

---

The unit should be set up in a well ventilated dry site, out of direct sunlight and away from radiators. The unit must not be located close to heat producing objects or devices, or anything which is heat sensitive or highly flammable.

---

The ventilation openings must not be covered or closed. If the system components are to be stacked then the device must be the top unit. Do not place any object on the top cover. The device is not designed to be operated on a soft surface (such as bedding, pillows, etc.).

---

When installing the unit on a shelf or in a cupboard it is essential to provide an adequate flow of cooling air, to ensure that the heat produced by the unit is dissipated effectively. Any heat build up will shorten the life of the unit and could be a source of danger. Be sure to leave free space of 10 cm around the unit for ventilation.

---

Liquid or particles must never be allowed to get inside the unit through the ventilation slots. Mains voltage is present inside the unit, and any electric shock could cause serious injury or death. Never exert undue force on mains connectors.

Protect the unit from drips and splashes of water; never place flower vases or fluid containers on the unit. Do not place naked flame sources, such as candle lights on the device.

---



---

Disconnect the mains plug at the wall socket before cleaning the case.

The surfaces of the case should be wiped clean with a soft, dry cloth only.

Never use solvent-based or abrasive cleaners!

Before switching the unit on again, check that there are no short-circuits at the connections, and that all cables are plugged in correctly.

---

If the device has been in storage, or has not been used for a protracted period (> two years), it is essential to have it checked by a specialist technician before re-use.

---



The terminals (marked with the ⚠-symbol) can carry high voltages.

Always avoid touching terminals and sockets and the conductors of cables connected to them. Unless ready-made cables are used, all cables connected to these terminals and sockets must always be deployed by a trained person.

---



In its original condition the unit meets all currently valid European regulations. It is approved for use as stipulated within the EC.

By attaching the CE symbol to the unit T+A declares its conformity the EC directives and the national laws based on those directives. The declaration of conformity can be downloaded from [www.ta-hifi.com/DoC](http://www.ta-hifi.com/DoC). The original, unaltered factory serial number must be present on the outside of the unit and must be clearly legible! The serial number is a constituent part of our conformity declaration and therefore of the approval for operation of the device. The serial numbers on the unit and in the original T+A documentation supplied with it (in particular the inspection and guarantee certificates), must not be removed or modified, and must correspond.

Infringing any of these conditions invalidates T+A conformity and approval, and the unit may not be operated within the EC. Improper use of the equipment makes the user liable to penalty under current EC and national laws.

Any modifications or repairs to the unit, or any other intervention by a workshop or other third party not authorised by T+A, invalidates the approval and operational permit for the equipment.

Only genuine T+A accessories may be connected to the unit, or such auxiliary devices which are themselves approved and fulfil all currently valid legal requirements.

---



The only permissible method of disposing of this product is to take it to your local collection centre for electrical waste.

Registration according to the EU directive  
"Waste Electrical and Electronic Equipment"  
WEEE-Reg.-No.: DE **72473830W**

---

The case should only be opened by a qualified specialist technician. Repairs and fuse replacements should be entrusted to an authorised T+A specialist workshop. With the exception of the connections and measures described in these instructions, no work of any kind may be carried out on the device by unqualified persons.

If the unit is damaged, or if you suspect that it is not functioning correctly, immediately disconnect the mains plug at the wall socket, and ask an authorised T+A specialist workshop to check it.

---

The unit may be damaged by excess voltage in the power supply, the mains circuit or in aerial systems, as may occur during thunderstorms (lightning strikes) or due to static discharges.

Special power supply units and excess voltage protectors such as the T+A 'Power Bar' mains distribution panel offer some degree of protection from damage to equipment due to the hazards described above.

However, if you require absolute security from damage due to excess voltage, the only solution is to disconnect the unit from the mains power supply and any aerial systems.

To avoid the risk of damage by overvoltages we recommend to disconnect all cables from this device and your HiFi system during thunderstorms.

All mains power supply and aerial systems to which the unit is connected must meet all applicable safety regulations and must be installed by an approved electrical installer.

---

The device is not designed for use by children. The device must not be operated unsupervised. Make sure that it is out of reach of children.

---

Batteries should not be exposed to excessive heat like sunshine, fire or the like.

---

Very loud continuous listening to program material via earphones, headphones and loudspeakers can lead to permanent loss of hearing. Prevent health risks and avoid permanent hearing at high volume.

---

If the device has to be stored, place it in its original packaging and store it in a dry, frost-free location. Storage temperature range 0...40 °C

---

# Connections

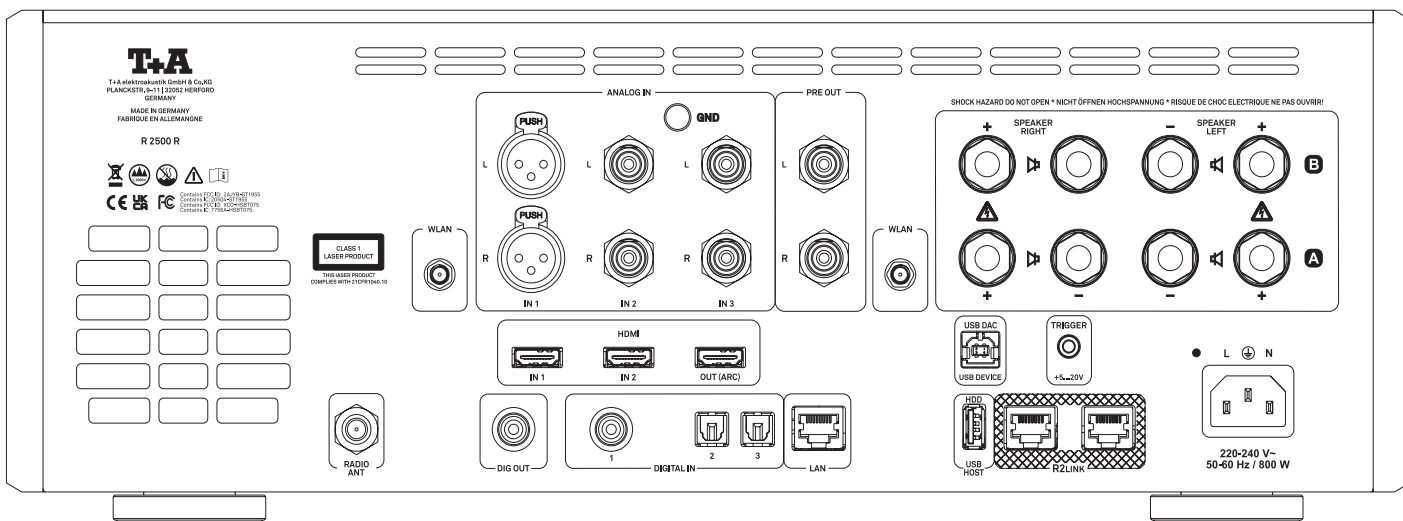

## ANALOG INPUTS / OUTPUT

### ANALOG IN

**IN 1**  
(balanced) Universal pre-amplifier line input for connecting any stereo audio or TV equipment fitted with symmetrical XLR outputs.

**IN 2 | IN 3** Universal pre-amplifier line inputs for connecting any stereo audio or TV equipment fitted with asymmetrical RCA (Cinch) outputs.

**i** The input ANALOG IN 2 can be upgraded to form an input for an analogue turntable by fitting a Phono MM or Phono MC module (optional accessories).

### ANALOG OUT

**PRE OUT** The pre-output of the R 2500 R provides analog stereo output signals with variable level. It is designed for operation with active loudspeakers, power amplifiers or for similar applications.

## CONTROL

**R2LINK** Control output sockets for the T+A R2Link - System, e. g. for connecting an additional R2Link device. The sockets are equivalent.

**TRIGGER** The R 2500 R can be turned on and off by means of a switching voltage (+5 ... +20 Volt) connected to this socket.

## USB STORAGE MEDIA

**HDD**  
(USB HOST) Socket for a USB memory stick or external hard discs  
The storage medium can be formatted with the FAT16, FAT32, extFAT, NTFS, ext2, ext3 or ext4 file system.

**i** The USB storage medium can be powered directly via the USB port provided that its current drain is in accordance with the USB norm. Normalised 2.5" USB hard discs can be connected directly, i.e. without a separate mains PSU.

## NETWORK CONNECTION

---

|      |  |
|------|--|
| LAN  | Socket for connection to a wired LAN (Ethernet) home network (Router).   |
| WLAN | Input sockets for the two supplied WLAN antennas. For the best possible reception, both antennas should always be connected. |

---

 *If no wired LAN connection is found, the R 2500 R will automatically activate its WLAN module and it will try to get access to your WLAN network.*

## USB AUDIO INPUT

---

|                         |  |
|-------------------------|--|
| USB DAC<br>(USB device) | Socket for connecting a PC or MAC computer.<br>At this input the R 2500 R accepts digital PCM stereo signals with sampling rates in the range 44.1 to 768 kSps, and digital DSD stereo signals from DSD64 to DSD512. (DSD 256 and DSD512 only with a Windows PC) |
|-------------------------|--|

---

 *If you wish the R 2500 R to convert audio files from a Windows PC connected to it, you must first install the appropriate drivers on the computer. No drivers are required if you are using a Linux or MAC computer (see the chapter 'USB DAC operation in detail!').*

## DIGITAL INPUTS / OUTPUT

---

|                    |   |
|--------------------|---|
| DIGITAL IN 1 ... 3 | Inputs for digital source devices with co-axial (RCA) or optical TOS-Link digital outputs. Sampling rates from 32kHz up to 192 kHz are supported. |
| DIG OUT            | Digital coaxial output for connecting an external recording device via coax cable.  |

---

## HDMI INPUTS

---

|                        |  |
|------------------------|--|
| IN 1, IN 2,<br>OUT/ARC | HDMI inputs (IN 1 and IN 2) for connecting a Blu-ray player or settop box. At the „OUT“ socket, the picture signals of the two input sockets „IN 1“ and „IN 2“ are available for passing on to a television. |
|------------------------|--|

 *If your TV set features the ARC function, the TV sound can be played back via the R 2500 R.*

## RADIO ANTENNA



---

|           |  |
|-----------|--|
| RADIO ANT | The R 2500 R features a 75 Ohm aerial input FM ANT, which is suitable both for a normal domestic aerial and a cable connection. For first-class reception quality a high-performance, professionally installed aerial system is indispensable. |
|-----------|--|

---

## LOUDSPEAKER

---

|   |   |
|---|---|
|  A    B | The R 2500 R is equipped with two pairs of speaker terminals. It is possible to connect two pairs of loudspeakers (2-zone operation). In this case, the impedance of each speaker must not be less than 8 ohms (according to DIN). Instead of 2-zone operation, the two outputs can also be used perfectly for bi-wiring operation. |
|---|---|

---

## POWER SUPPLY

---

This socket is for mains connection.  
For correct connection refer to the sections ‚Installation and Wiring‘ and ‚Safety Notes‘.

# Installation and connection

## Installation

---

Carefully unpack the device and store the original packaging carefully. The carton and packing material are specially designed for this device and will be a safe container during any later transports. Set up the device at a proper place. Please observe all notes on connection and set-up in the chapter Safety notes (pages 8 and 9).

Please consider the weight of the device. Never place the device on an unstable surface; the machine could fall off, causing serious or even fatal injury. Many injuries, especially to children, can be avoided if the following simple safety precautions are observed:

- Use only such items of furniture which can safely bear the weight of the device.
- Ensure that the device does not project beyond the edges of the supporting furniture.
- Do not place the device on tall furniture (e.g. bookshelves) without securely anchoring both items, i.e. furniture and device.
- Explain to children the hazards involved in climbing on furniture to reach the device or its controls.

When installing the unit on a shelf or in a cupboard it is essential to provide an adequate flow of cooling air, to ensure that the heat produced by the unit is dissipated effectively. Any heat build up will shorten the life of the unit and could be a source of danger. Be sure to leave free space of 10 cm around the unit for ventilation.

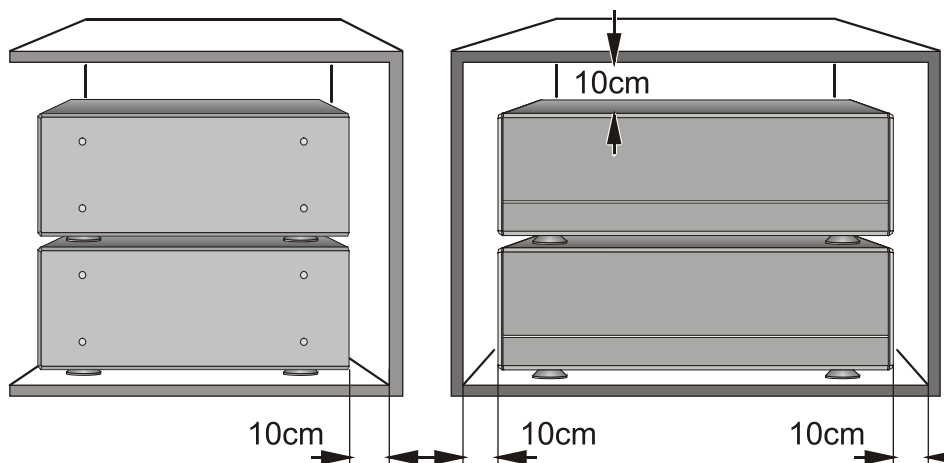

If the system components are to be stacked then the amplifier must be the top unit. Do not place any object on the top cover. The unit must be set up in such a way that none of the connections can be touched directly (especially by children). Be sure to observe the notes and information in the section 'Installation and Wiring'.

---

## Connection

---

To use the R 2500 R with all its functions and sources, first you have to make some important connections and/or connect antennas.

The necessary connections are described below:

---



***Do not connect the R 2500 R and the other components to the power supply until all the necessary connections have been established.***



The terminals (marked with the ⚡-symbol) can carry high voltages.

Always avoid touching terminals and sockets and the conductors of cables connected to them. Unless ready-made cables are used, all cables connected to these terminals and sockets must always be deployed by a trained person.

---

# Connection of source devices

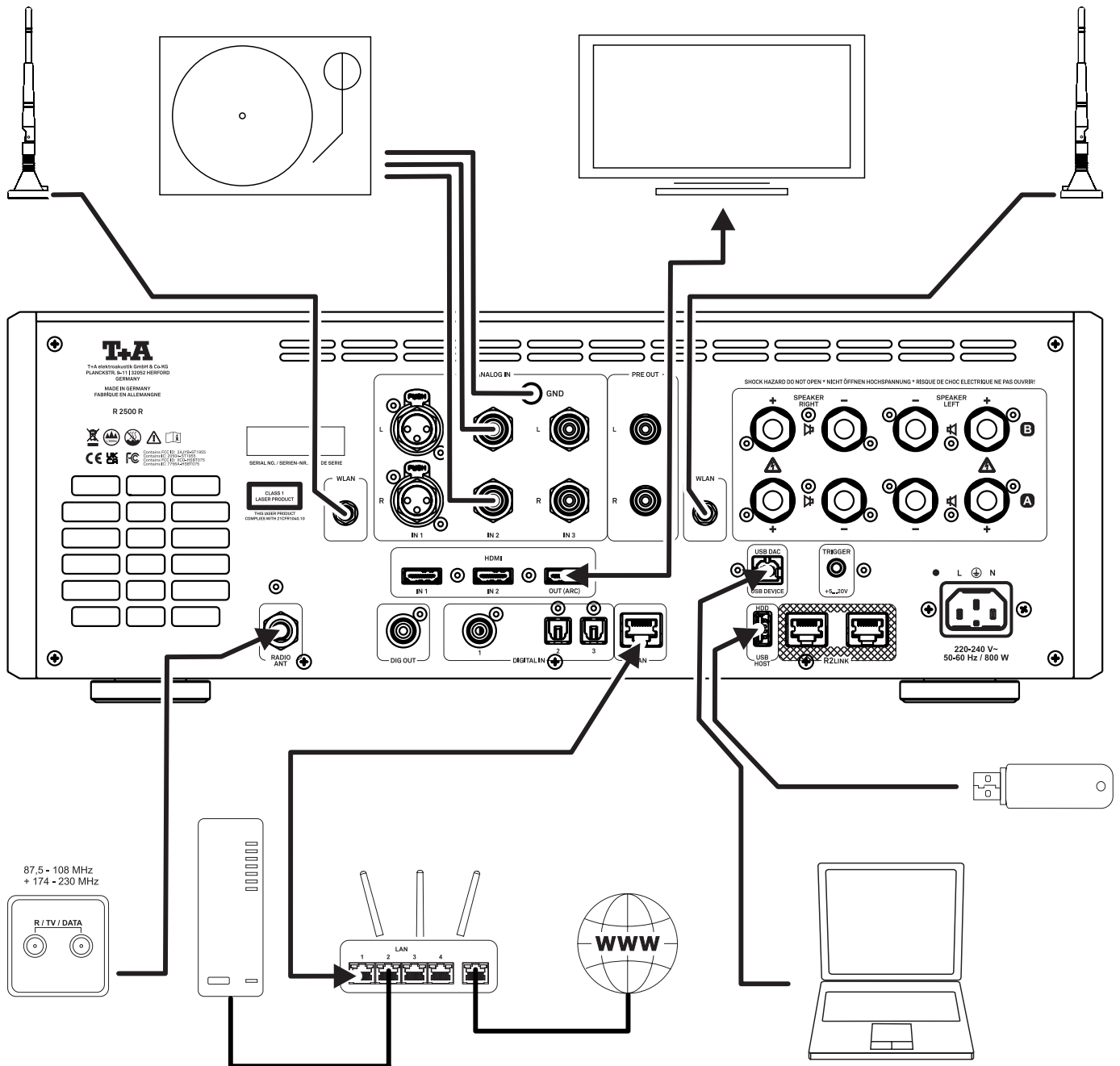

# Connection of loudspeakers

R 2500 R

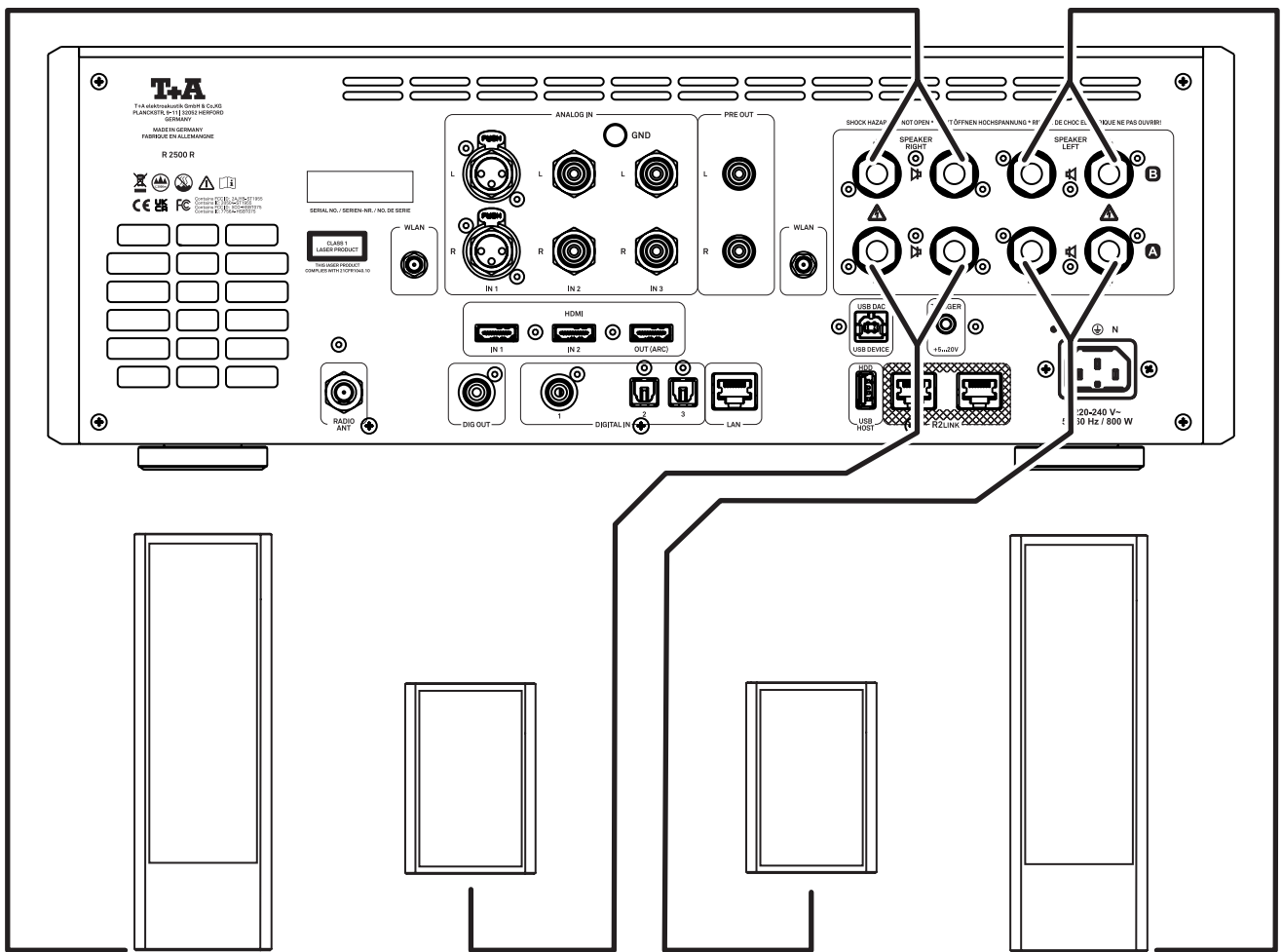

Rechter Lautsprecher /  
Right loudspeaker

Linker Lautsprecher /  
Left loudspeaker

# Connection of turntable G 2000 R

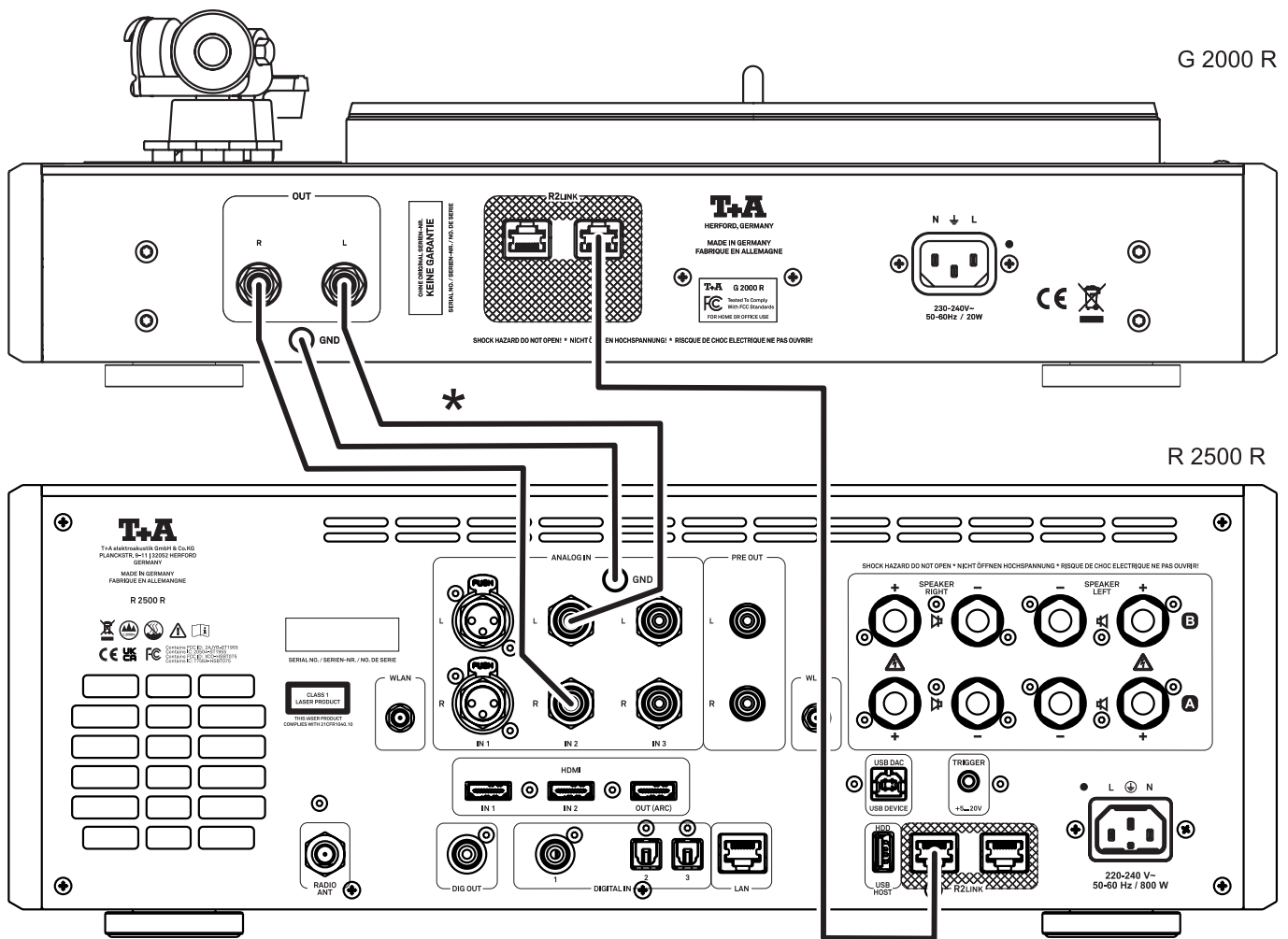

# Controls and functions

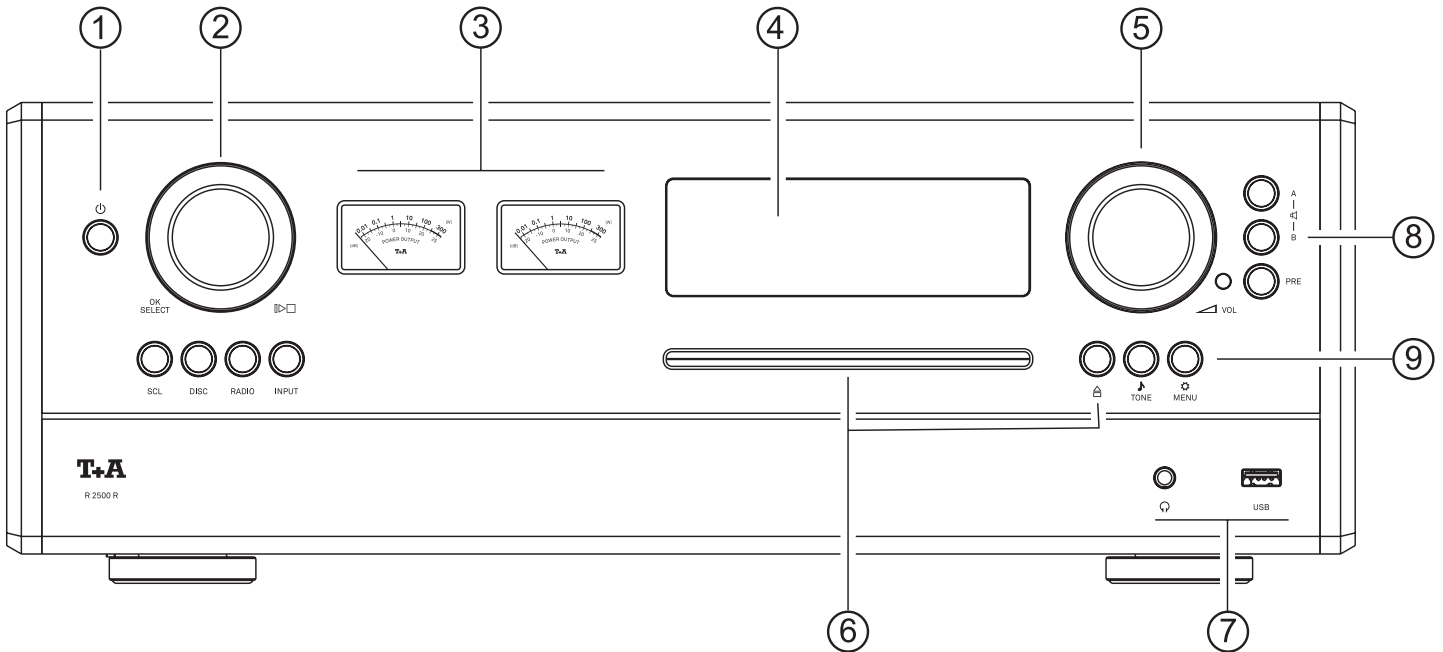

## ① On- / Off switch



Pressing this button briefly switches the device on and off. When the unit is switched on the indicator LED around the button lights up. Please note the hints in the chapter *Automatic power down function* on page 24.

**i** The power button remains dimly lit even in comfort stand-by mode, to indicate that the R 2500 R is ready for use.

## ② Navigation and control / Source selection

**Source selection** To select a source, first press the corresponding source category button (SCL, DISC, RADIO or INPUT) and select the desired source from the displayed list by turning the rotary knob. The selected source will be activated by briefly pressing the rotary knob.

**Control** Rotating this control selects a track for playback; the selected track then appears on the screen. As soon as the desired track number lights up, the track can be started by pressing the incremental control.

**Navigation** The rotary knob is also used for functions such as navigating within lists, controlling menus, and creating playback programs.

## ③ Level meter

The purpose of the VU meter is to display and monitor the level of left and right channel. The VU meter is used to display and control the level of the R 2500 R. This display shows an average output level.



## ④ Display

The graphic screen of the R 2500 R displays all information regarding the status of the machine, the music track currently being played and the radio station currently tuned. The display is context-sensitive and varies according to the capabilities and facilities of the service or medium to which you are currently listening.

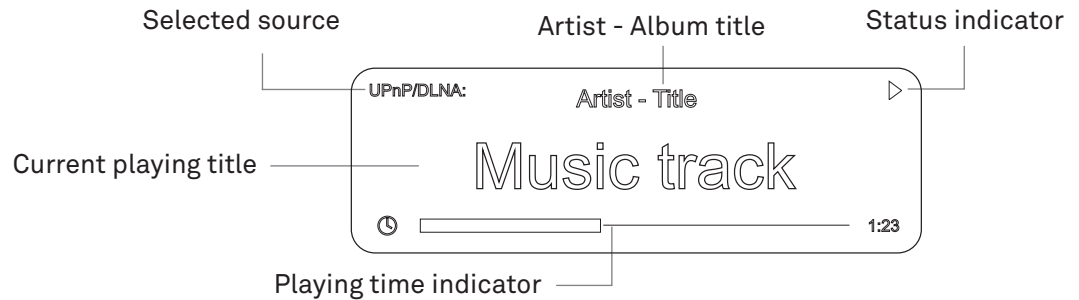

## ⑤ Volume control



This rotary knob is used to set your preferred volume in accurate 1 dB increments. The value currently set is displayed on the screen.

## ⑥ Disc drive mechanism

Feed slot for 12 cm discs. Insert the disc with the labeled side facing up until the disc feeds automatically.



A brief press will eject the inserted CD.

## ⑦ Headphones and USB Front sockets

Phones

Balanced Pentacon jack socket 4.4 mm for stereo headphones with an impedance of at least 16 Ohms .  
An adapter is available in the T+A accessories range for connecting headphones with a standard 6.3 mm jack socket.

USB

Socket for a USB memory stick or an external hard disc.  
The storage medium can be formatted with the FAT16, FAT32, NTFS, ext2, ext3 or ext4 file system.  
The USB storage medium can be powered via the USB socket provided that its current drain meets the USB norm (< 500 mA). Normalised 2.5" USB hard discs can be connected directly to this socket, i.e. they require no mains PSU.

## ⑧ Outputs

PRE

This button switches the preamplifier output of the R 2500 R on and off. If the output is switched on, the button lights up.

A | B

The loudspeaker groups A and B are switched on and off by pressing the related button.

## ⑨ Tone and system settings

  
MENU

Opens the menu for system configuration.(see chapter „Settings“)

  
TONE

Pressing this button opens and closes the tone control menu.  
(see chapter „Tone configuration“)

# Remote control

## On / off switch



A brief press switches the R 2500 R on and off.

## Source selection

To select the desired source, first press the button for selecting the source category, e.g. Radio, and then choose the desired source from the list with the up-down cursor buttons and confirm with the OK button.

**SCL** Selects the SCL (Streaming Client) category (e.g. access to music servers, streaming services or similar).

**DISC** This button selects the DISC function as source.

**RADIO** Selects the radio sources category.

**INPUT** A brief press on this button opens the category list for all external sources, e.g. as digital and analog inputs.

**★ 1** On these two buttons you can save your two most preferred sources as hotkeys for a faster selection.  
**★ 2**



### NOTE

*Not required sources can be deactivated in the system settings for an even more comfortable source selection.*

## Muting

**PRE** Switches the preamplifier output of the R 2500 R on and off.

**🔊 A | B** Switches the speaker outputs for listening zone A or B on and off.

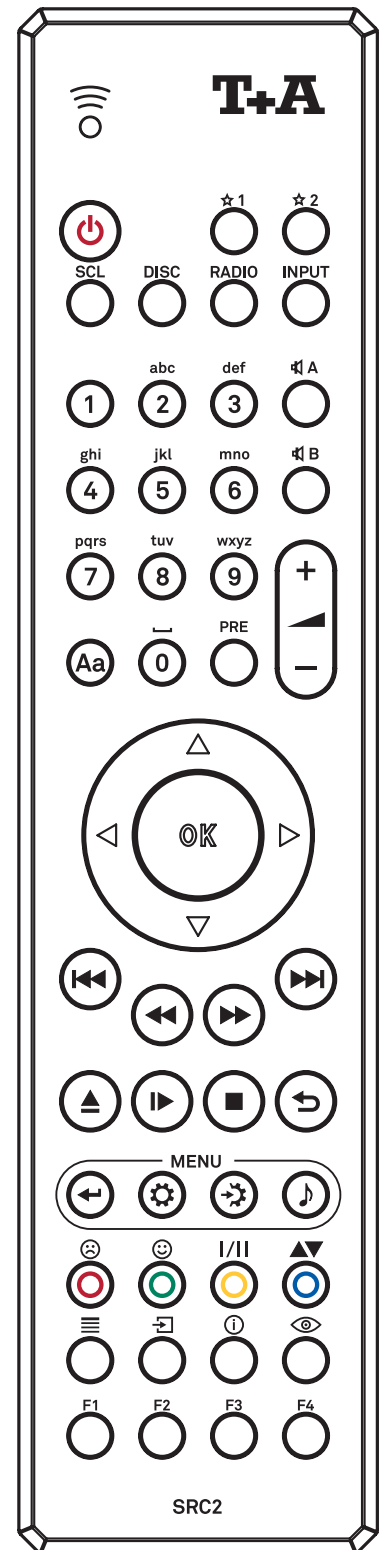

## Volume control



### Increase / decrease volume

The volume can be increased / decreased in steps by tipping one of the volume buttons. The current volume level is displayed on the display screen. If one of the buttons is kept pressed for approx.. 1 seconds the volume increases / decreases continuously until the button is released.

## Alpha-numeric entry



To enter a source name, user data or network parameters, first activate the relevant input field with the **OK** button.

If necessary, existing entries can be deleted by pressing the **cursor left** button repeatedly.

Enter the desired character string using the alphanumeric keypad on the remote control.

Press the **OK** button to confirm the entry.

Use the **Aa** button for toggling between numbers, capitals and lower-case letters. The bottom line of the screen shows which input mode is currently selected.

**123**

1234567890

**abc**

abcdefghijklmnopqrstuvwxyz -\*/^={ } ( ) [ ] < > . , ? ! : ; \ " ' \_ @ \$ % & # ~ 0 1 2 3 4 5 6 7 8 9

**ABC**

ABCDEFGHIJKLMN OPQRSTUVWXYZ -\*/^={ } ( ) [ ] < > . , ? ! : ; \ " ' \_ @ \$ % & # ~ 0 1 2 3 4 5 6 7 8 9

## Navigation

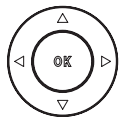

Cursor up selects the previous point within a list / select button.

Cursor down selects the next point within a list / select button.

Cursor left returns to the previous point / change button.

Cursor right confirms the input / change button.

The OK button is used for confirmation during input procedures.

## Playback functions



Selects the previous or next track during playback



Rewind and fast forward to search for a particular passage.  
FM Radio: Manual station search



A brief press, while disc is stopped, ejects the disc.



Starts playback (Play function)  
During playback: halts (Pause) or resumes playback



Stops playback.



Repeat functions (not possible with all media)  
Brief press: Repeat Track, Repeat ALL, NORMAL  
Long press: Mix-Mode (Shuffle) ON / OFF  
Brief button presses in MIX mode: Mix, Repeat Track, Repeat Mix

## System and tone configuration



Use this button to return to the previous level in lists during menu navigation.



A brief press opens the menu for system configuration. (Refer to chapter entitled *Settings*)











A brief press opens the menu for station search (Refer to chapter entitled *Radio Operation*)



A brief press opens the tone configuration menu. (Refer to chapter entitled *Tone configuration*)

## Function buttons

|   |   |
|---|---|
|   | Adds a favorite to the Presets list<br>In the system configuration menu: Activates a source   |
|   | Removes a favorite from the Presets list.<br>In the system configuration menu: Deactivates a source   |
|   | FM Radio: Button for switching between Stereo and Mono reception.<br>The Stereo setting is constantly displayed in the screen window by a  symbol.<br>The Mono setting is constantly displayed in the screen window by a  symbol. |
|   | Calls up the search function for SCL, USB-Media, Internetradio, Podcasts and Music services.<br>Activates the sort function within a Favourites list.   |
|  | Displays the Favourites list created on the R 2500 R  |
|   | Cycles through the various screen displays.<br>Detailed display with / without CD text / Radiotext (if present) and large display with / without CD text / Radiotext (if present).  |

*\*Buttons not described in this chapter are not required for operating the R 2500 R.*

## Range

When operating by remote control, please hold the SRC2 in the direction of the remote control receiver (located next to the volume knob).

The range of the remote control is approx. 5..6 m.

The line of sight between SRC2 and the remote control receiver must not be interrupted by obstacles.

The direct incidence of interfering light (e.g. from fluorescent and energy-saving lamps) into the receiver should be avoided at all times, as otherwise the range of the remote control can be considerably reduced.

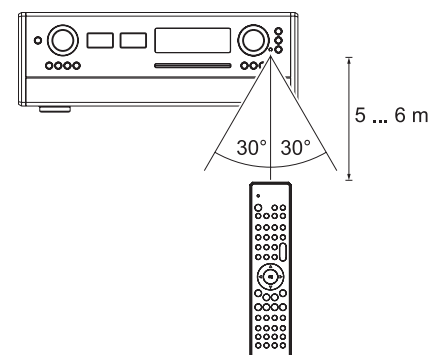

## Replacing the battery

To replace empty batteries, remove the entire back of the SRC2 by sliding it downwards (1) and remove it completely as shown below (2). Insert three new cells of the LR 03 (MICRO) type, taking care to maintain correct polarity as shown. Please note that you must always replace all the cells.

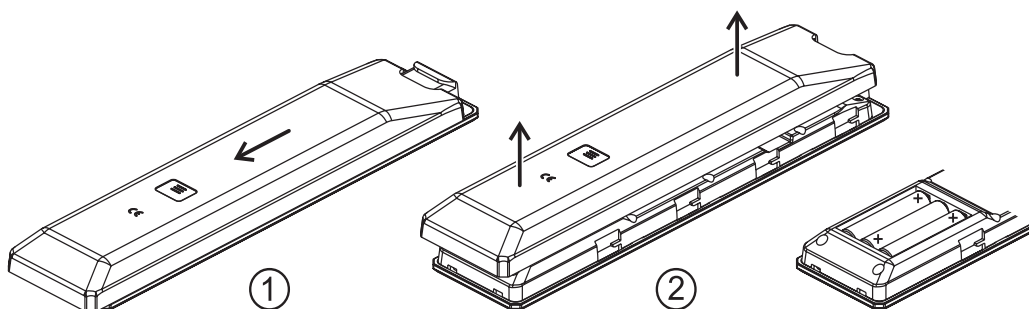

## Important information

---



- If the battery is replaced improperly, there is danger of explosion. Always replace batteries by batteries of the same or an equivalent type.
- Keep new and used batteries well away from children.
- If you cannot close the battery compartment securely, cease using the product, and keep it away from children.
- Batteries should not be exposed to excessive heat like sunshine, fire or the like.
- Very low air pressure may result in explosion of the battery, or leakage of flammable liquids or gases.
- Protect the remote control from humidity, coldness, heat and dust.
- *Exhausted batteries must never be thrown into the household waste! They should be returned to the battery vendor (specialist dealer) or your local toxic waste collection point, so that they can be recycled or disposed in a proper way. Most local authorities provide collection centres for such waste, and some provide pick-up vehicles for old batteries.*

## T+A Music Navigator App

### Download

---

Two Apps are available for controlling the sound system using the Apple iOS and Android operating systems. Please download the appropriate version from the Appstore and install it on your tablet PC or smartphone.

You will find the App under the name “TA MUSIC NAVIGATOR” in the Appstore. Alternatively you can scan the QR code printed below.

Android Version



Apple iOS Version



# Configuration

## Menu / Tone operation

### Operation on the device

- To call up the **system configuration / tone configuration** menu, press the **MENU / TONE** button ① on the front of the R 2500 R.
- Select an item in the **MENU / TONE** configuration with the rotary knob on the left ②.
- To change a selected item, confirm by pressing the rotary knob and then change it by turning the knob.
- To confirm the setting, press the knob again after the change.
- A long press on the rotary knob aborts the entry .
- By pressing the rotary knob for a long time, you can also return to the previous menu level.
- To exit the **MENU / TONE** configuration, press the button.

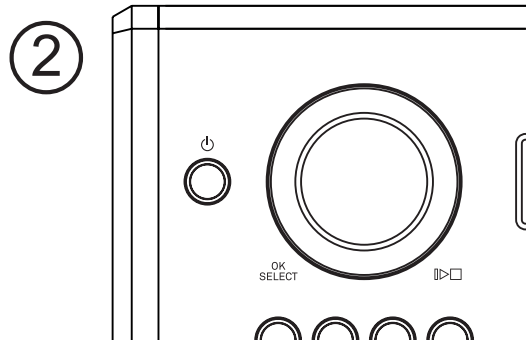
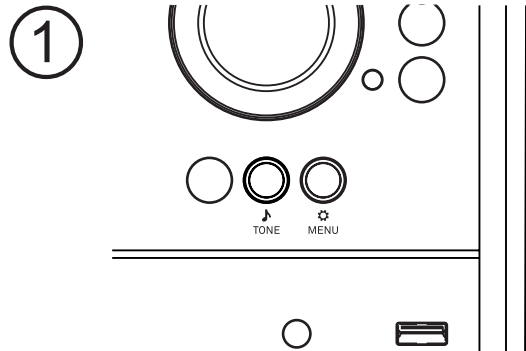

### Operation by remote control

- A brief press on the **MENU** ⚙️ / **TONE** 🎵 button on the remote control opens the **configuration**.
- Use the **cursor up / down** buttons to select an item in the menu.
- To change a selected menu item, first press the **OK** button and then use the **cursor left / right** buttons to alter the setting.
- To confirm the setting, press the **OK** button again after changing it.
- To cancel a change, you can always abort by a brief press on the **←** button.
- Press the **←** button to return to the previous menu level.
- To exit the **MENU / TONE** configuration, press the button.

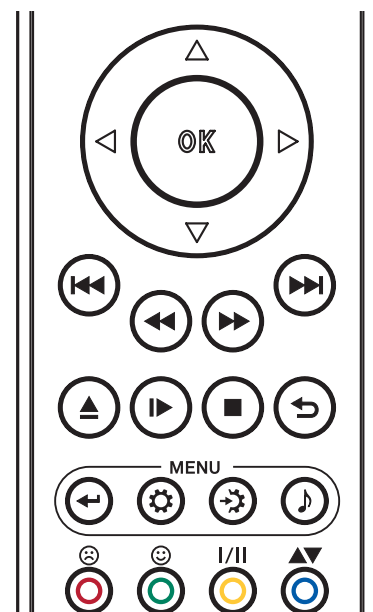

# System configuration

---

## Source configuration

Under this menu item you can disable not used sources, and assign a plain text name to each source which is in use; this name then appears in the screen displays.

You can also assign a plain text name for the display to the external sources (digital inputs and Bluetooth).

When this menu item is called up with the **OK** button, a list of all sources of the R 2500 R appears.

Each source is followed by the displayed plain text name or the note *Enabled* for an active source or *Disabled* if the source is deactivated.

### Disable not required sources

Pressing the ☹ button on the SRC2 deactivates the selected source.

To activate a disabled source, press the ☺ button briefly.

### Change the source name

To change the plain text name, first select the corresponding source and press the **OK** button.

Delete the previous name by repeatedly pressing the **cursor left** button.

Now use the alpha-numeric keypad of the SRC2 to change the name as required, then confirm your choice with **OK**; this saves the settings for that source. Alternatively the App (T+A MusicNavigator G3) can be used to change the name.

To switch between numeric and alphanumeric input as well as upper/lower case, press the **Aa** button.

If you should wish to restore the factory default source name, erase the whole name before saving the empty field with the **cursor left** button: this action resets the display to the standard source names.

---

### Passthrough

If you wish to connect a device with its own volume control (e.g. TV set or surround decoder), this menu point can be used to disable the volume control of the R 2500 R for the analog inputs (Analog IN 1-3 /pass-through mode).

 *You should only select this setting if a device with its own volume control is connected to the unit. Ensure that the volume of the source device is turned down to zero before connecting it to the R 2500 R, otherwise the speakers connected to it may be damaged through overloading.*

---

### Trigger

The R 2500 R offers the option to be switched on and off remotely using a trigger signal (switching voltage, +5 ... +20V). Many external surround decoders are designed to deliver the required trigger output signal. The R 2500 R can be switched on and off in parallel with the decoder, and at the same time to select the appropriate source and the correct volume level. The active Trigger function is displayed on-screen next to the selected source by means of the "TRG" symbol. If you wish to use this function, activate the Trigger function and select the appropriate source.

|   |  |
|---|--|
| <b>Volume after power on</b>                  | <p>Here you can select whether the R 2500 R switches on with the volume selected before the device was switched off, a maximum permissible volume or always the same volume.</p> <p>Unchanged<br/>If you select this setting, the device switches on with the volume set before it was switched off.</p> <p>Limited<br/>This setting allows you to define a maximum permissible volume level after power-on. The value can be set under the menu item „Value“.</p> <p>Fixed value<br/>If this option is activated, the R 2500 R always switches on with the volume value set in the menu item „Value“.</p>   |
| <b>Display Brightness (Screen Brightness)</b> | <p>At this point you can adjust the brightness of the integral screen to suit your personal preference for normal use.</p>   |
| <b>Display mode</b>                           | <p>This menu item offers the choice between three different display operation modes:</p> <ul style="list-style-type: none"> <li>• Always on</li> <li>• Temporary</li> <li>• Always off</li> </ul> <p>Selecting ‚Temporary‘ will switch the display is on for a short while each time the R 2500 R is being operated. Shortly after operation the display will be switched off again automatically.</p>   |
| <b>VU- Meter Colour Profile</b>               | <p>Here you can adjust the backlighting of the VU meters according to your individual preferences.</p> <p>In the Standard profile, the values for red, blue and green are each set to 19.</p> <p>If the User defined profile is used, the colour values can be adjusted in the range of 0-30.</p> <p>The Standard Colors setting resets the colour settings to the factory-set value of 19.</p>  |
| <b>Language</b>                               | <p>In this menu item you define the language to be used for the displays on the screen of the front panel of the R 2500 R.</p> <p>The language used for data transferred to the machine, e.g. from an Internet radio station, is determined by the supplying device or the radio station; you cannot define the language on the R 2500 R.</p>  |
| <b>Device name</b>                            | <p>This menu point can be used to assign an individual name to the R 2500 R. In a home network the device then appears under this name.</p>  |
| <b>Energy Saver</b>                           | <p>The R 2500 R features two stand-by modes: ECO Standby with reduced stand-by current drain, and Comfort Standby with additional functions, but slightly higher current drain. You can select your preferred stand-by mode in this menu point:</p> <p>On (ECO standby):<br/>Active functions in ECO standby mode:</p> <ul style="list-style-type: none"> <li>• Power-on at the device itself.</li> <li>• Automatic power-down after ninety minutes without signal (only possible with certain sources).</li> </ul> <p>Off (Comfort standby):<br/>The following expanded functions are available:</p> <ul style="list-style-type: none"> <li>• Unit can be switched on using the app.</li> <li>• The automatic power-down function is disabled in Comfort standby mode.</li> <li>• The picture and sound signals at the HDMI 1 and 2 sources are passed on to the connected TV even if the device is in standby mode.</li> </ul> |
| <b>Network</b>                                | <p>All network settings can be carried out at this menu point. For a detailed description on setting up a LAN or WLAN connection please also refer to the section entitled “Network configuration” on page 27.</p>   |
| <b>Device Info</b>                            | <p>At this menu point you will find information on the status of the installed software and the factory reset.</p>   |



## Tone configuration and converter settings

---

### **Balance**

This menu point is used to alter the balance in level between the left and right channels, e.g. to compensate for non-symmetrical loudspeaker positioning. The balance can be adjusted in increments of 1 dB (85 steps); the screen always displays the current value.

---

### **Loudness**

The R 2500 R is equipped with a volume-dependent tone control (LOUDNESS) circuit, which compensates for the frequency-dependent sensitivity of the human ear at very low volume levels, due to the characteristics of aural physiology.

This menu point is used to switch the loudness circuit on and off.

---

### **Loudness level**

This menu point is used to adjust Loudness to suit the loudspeakers and the listening room.

---

### **Tone control**

This menu point can be used to disable (by-pass) the R 2500 R's tone controls.

To switch off the tone controls, select the "OFF" setting. When the tone controls are switched off, any adjustments you make to the following menu points "BASS" and "TREBLE" have no effect.

---

### **Treble**

In this menu item treble can be set in the range of -6...0...+8 dB.

---

### **Bass**

In this menu item bass can be set in the range of -6...0...+8 dB.

---

## Tone configuration and converter settings

---

### PCM mode

The R 2500 R can exploit four different filter types offering different tonal characters:

- **OVS long FIR**

is a classic FIR filter with an extremely linear frequency response.

- **OVS short FIR**

is a FIR filter with improved peak handling.

- **OVS Bezier / FIR**

is a Bezier interpolator combined with a IIR filter. This process produces a result very similar to an analogue system.

- **OVS Bezier**

is a pure Bezier interpolator – offering perfect “timing” and dynamics.

For special applications, e.g. if the source device is doing the upsampling (such as a PC with Signalyst® HQ player), the upsampling in the R 2500 R can be deactivated. The following two NOS modes are available for this purpose.

- **NOS 1**

With this setting the upsampling of the R 2500 R is deactivated and the analog output filter is automatically set to 60 kHz for sampling rates of 44.1 and 48 kHz. For higher sampling rates, the setting you selected under the *Bandwidth* menu item is used.

- **NOS 2**

If you select this setting, upsampling of the R 2500 R is deactivated. The analogue output filter always has the value selected under the menu item *Bandwidth*.

---

### DSD mode

The R 2500 R offers two different converter modes for DSD playback.

- **DSD 1**

This is a long filter with very low noise and very good noise rejection.

- **DSD 2**

In DSD2 mode, two shorter filters operate in parallel. This filter produces even lower distortion than DSD1 mode.

---

### Phase

With particular instruments or voices the human ear is certainly capable of detecting whether absolute phase is correct or not. However, absolute phase is not always correctly recorded.

In this menu item the phase of the signal can be changed from normal to inverse phase and back.

---

### Bandwidth

In this menu item, the bandwidth of the analogue output filter can be switched between 60 kHz (normal mode) or 120 kHz (‘WIDE’ mode).

The ‘WIDE’ setting allows a more spacious music reproduction.

---

# Network configuration

## General information

All network settings are carried out in the system settings under the menu item Network.

If the R 2500 R is not connected to a wired network via its LAN port, the WLAN module is activated and the Network menu displays the menu items for setting up the WLAN connection.

- i** If you want to connect the R 2500 R to the home network via WLAN, the LAN port must remain free.
- i** Important: once an internet connection has been established please check if an update is available and perform it before operation the device. Refer to chapter entitled Firmware update page 44.

## Menu operation

- Open the system settings menu by pressing the  button on the remote control.
- Select the Network menu item with the **cursor up / down** buttons and confirm with the OK - button.
- In the network menu, select the network parameter to be changed with the **cursor up / down** buttons and activate the entry with the OK - button.
- Now you can change the setting depending on the type with the following buttons:  
**cursor left / right** buttons at simple selection (ON/OFF)  
**cursor up / down** buttons at IP addresses and alphanumeric input of text.
- After the setting has been made or the address has been entered completely, confirm the entry with the OK-button.

- i** The network parameters can be set using the remote control or via App (T+A MusicNavigator G3).

## Connection via LAN (cable connection)

- Connect the R 2500 R to an operational network (router) or power line modem via the rear LAN port.
- Switch on the R 2500 R.
- Usually, an IP address is automatically assigned to the R 2500 R by your router (via DHCP) and the R 2500 R is ready for operation after the start-up process of the streaming module.
- If this is not the case, open the network menu (Network) and set the network parameters listed below according to your network settings.

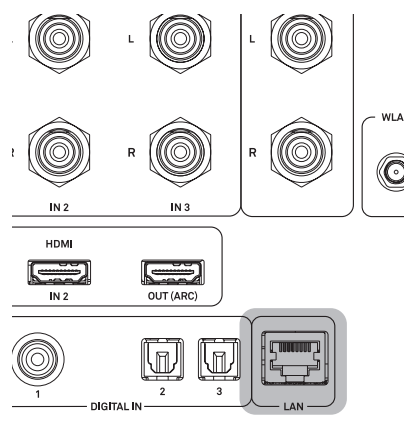

| Menu item       | Setting / Explanation  |
|-----------------|--|
| MAC             | The MAC address is a hardware address which uniquely identifies your machine. The address displayed is determined by the manufacturer, and cannot be altered |
| Connction state | Shows the connection state: WLAN, LAN or not connected   |

|                          |  |
|--------------------------|--|
| <b>DHCP</b>              | <p><b>on</b></p> <p>If your network includes a DHCP server, please select the ON setting at this point. In this mode an IP address is automatically assigned to the R 2500 R by the router. The screen shows only the MAC address and the message DHCP state ON. In this case the address input fields shown in the illustration do not appear in the menu.</p> <p><b>off</b></p> <p>If your network does not include a DHCP server, please select the OFF setting. In this mode you must configure the following network settings manually. Please ask your network administrator for the addresses to be entered for your network.</p> |
| <b>IP</b>                | IP Adress of the R 2500 R  |
| <b>Subnet mask</b>       | Network mask   |
| <b>Gateway</b>           | IP Adress for the router   |
| <b>DNS</b>               | Name / IP of the name server (optional)  |
| <b>Store and exit?</b>   | Stores the network parameters, and restarts the R 2500 R with the new settings   |
| <b>Discard and exit?</b> | Closes the menu: data already entered is discarded   |

## Connecting to WLAN (radio connection)

- Connect both of the supplied WLAN antennas to the WLAN sockets on the back of the R 2500 HV. Depending on your reception and set-up situation, the antenna can be mounted directly on the socket on the back or together with the magnetic base supplied.

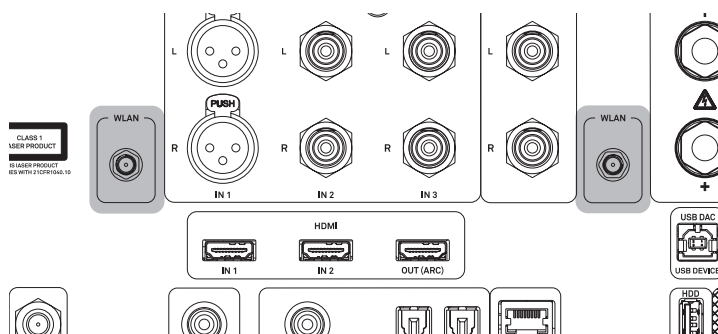

- For setting up the WLAN connection, open the menu for system settings and then the menu item Network.

| Menu item              | Setting / Explanation   |
|------------------------|---|
| <b>MAC</b>             | The MAC address is a hardware address which uniquely identifies your machine. The address displayed is determined by the manufacturer, and cannot be altered. |
| <b>Connction state</b> | Shows the connection state: WLAN, LAN or not connected.   |
| <b>WPS autoconnect</b> | Activates the WPS function to connect the R 2500 HV to the WLAN via WPS. See chapter <i>Setup via the WPS function</i> .                                      |
| <b>Scan for WLAN</b>   | Starts the scan for WLAN networks that are within reception range..   |

**i** All other menu items are the same as for the connection via LAN. See above for more information.

## Configuration using the WPS function

---

- First activate the WPS-function of the Router or Repeater to which you wish the R 2500 R to be connected. For details please refer the manual of the device in question.
- Start the WPS-Autoconnect function of the R 2500 R within 2 minutes.
- Use the **cursor up / down** buttons to select the menu point “WPS-Autoconnect”, then confirm your choice with OK - the button.
- After the connection is established, the line *Status* shows the connected WLAN network.
- Finally select the “Store and exit?” menu point and press the OK - button to accept the settings.

## Manual setup of the WLAN connection

---

- First select the Scan for WLAN menu item and confirm it with the OK - button.
- A list of the WLANs found appears.
- Use the **cursor up / down** buttons to select the WLAN to which you wish the R 2500 R to be connected, and confirm your choice with the OK - button.
- Enter the network password (passphrase) and confirm your entry with OK.
- Confirm and store the settings by selecting the item *Store and exit?* and pressing OK.
- Finally, select the menu item *Store and exit?* again and confirm the settings with the OK - button again.

## Setting up the WLAN connection via the T+A app (TA Music Navigator)

---

For an easy setup of the network connection, the R 2500 R has an access point function. This is automatically activated whenever the device is neither connected to the network via cable nor a WLAN network has been configured. This state can be restored at any time by resetting the R 2500 R to the factory default settings (see p. 24 item Device info).

Proceed as follows to set up the device:

---

### Using Android

- Connect the smartphone or tablet PC on which the T+A TA Music Navigator app is installed to the WLAN access point.
- The name of the network (SSID) starts with T+A AP 3Gen\_..... a password is not required.
- Start the app. Permission for standard required.
- The app detects the access point and automatically starts the setup wizard.
- To set up the WLAN, you must go through the individual steps of the app's setup wizard.
- Exit the app and then connect the smartphone or tablet to the previously set up WLAN.
- After restarting the app, the R 2500 R will be automatically searched for.
- Once the R 2500 R has been detected, it can be selected for playback.

---

### Using iOS (Apple)

- The R 2500 R supports the Wireless Accessory Configuration,(WAC).
- Power on the R 2500 R.
- Open the menu for the settings/WLAN on your iOS mobile device.
- As soon as the device is started, you will find under the item Set up new Airplay speaker an entry that starts with SET UP NEW AIRPLAY SPEAKER R2500R-xxxxxx.
- After selecting this entry, you can select the network to which your R 2500 R can be connected.
- After confirming the selection, the configuration data of the network is automatically transferred to the device and the R 2500 R connects to the selected network.

# SCL Streaming Client operation

## General information

---

The R 2500 R includes a streaming client (SCL).  
It enables music playback from UPnP network servers (NAS), or music streaming services e.g. Tidal, Qobuz and Roon and Podcasts.

 *To make use of music services you may need to take out a paid subscription with the appropriate provider.*

*The use of music services requires the entry of access data (username and password). These access data can only be created by means of the T+A Music Navigator App G3 with the OAuth (Open Authorisation) Protocol. To do this, select the music service you want subscribe in the app and follow the login instructions. If you want to log out of a music service, you can use the Logout menu item in the App or on the device the menu of the selected music service.*

*The exact form of the list format and the preparation of the content depends mainly on the capabilities of the network server (NAS) / music streaming service.*

## Source selection

---

Choose the desired listening source by pressing the SCL-button on the SRC2 and then choose the desired source from the list with the **cursor up / down** buttons and confirm with the OK button. To select the source on the front panel of the R 2500 R press the SCL button and turn the SELECT-knob to the desired source and confirm with a short press on the knob.

## Local Musicserver (UPnP/DLNA compatible NAS)

---

- The R 2500 R supports playback from a local NAS with a UPnP/DLNA compatible music server application.
- Compatible music servers connected to the network are recognized and displayed by the R2500R
- Use the T+A Navigator App, the remote control or the left rotary knob to select a server, navigate through the folders and start to playback of the music.

## Streaming Services of the Streaming Client

Podcast, Amazon Music, Deezer, HIGHRESAUDIO, Qobuz, Tidal, Spotify, Roon Ready

## Spotify Connect

---

- The R 2500 R supports playback via Spotify.
- Use your phone, tablet or computer as a remote control for Spotify .
- Go to [spotify.com/connect](https://spotify.com/connect) to learn more
- Connect the R 2500 R and the Smartphone/Tablet to the same network.
- Start the Spotify App and log in to Spotify.
- Start the playback via the Spotify App
- The R 2500 R appears in the app in the list of available devices.
- To start playback on the R 2500 R , select it by tapping on the R 2500 R V.
- Playback now starts via the R 2500 R.
- Spotify Connect offers presets and resume playback.



## Apple Airplay

---

- The R 2500 R supports playback via Apple AirPlay.
  - To do this, connect the R 2500 R and the smartphone/tablet to the same network.
  - Start the desired AirPlay-compatible app (e.g. iTunes or similar).
  - Start playback.
  - R 2500 R appears in the app, in the list of available devices
  - To start playback on the R 2500 R , select it from the list by tapping it.
  - The source on the R 2500 R will automatically switch to AirPlay and playback will start on the R 2500 R.
- You can find more information at: <https://www.apple.com/airplay/>



## Tidal Connect

---

- The R 2500 R supports playback via TIDAL connect.
- Use your smartphone, tablet or computer as a remote control for TIDAL.
- Visit <https://tidal.com/connect> to learn more.
- To start playback from your mobile device, connect the R 2500 R and smartphone/tablet to the same network.
- Launch the Tidal app and log in.
- Start playback via the Tidal app.
- The R 2500 R appears in the list of available devices.
- To start playback on the R 2500 R, select it by tapping on it.
- The source on the R 2500 R automatically switches to TIDAL Connect and playback starts on the R 2500 R.



 *Apple Airplay and Tidal Connect do not exist as menu items in the R 2500 R menu list*

---

## Roon Operation

---

### General information

The R 2500 R supports playback via Roon.  
Roon is a fee required software solution that manages and organizes your music stored on a server.  
Furthermore the streaming service TIDAL and Qobuz can be integrated.

### Playback

The operation is exclusively done via the Roon-App. The R 2500 R is recognized as a playback device (client) and can be selected for playback in the app. As soon as Roon is used for playback, ROON appears on the R 2500 R display as source.  
Further information about Roon and its operation can be found at:  
<https://roonlabs.com>



# CD player operation

## Source selection

Press the *DISC* button on the front panel of the R 2500 R or the source selection button *DISC* on the SRC2 remote control.

## Insert and eject a disc

- Select Disc as source.
- Insert the disc into the drive with the label side facing up until the disc is automatically pulled in (see illustration).
- Briefly press the ▲ button to eject the CD.
- As soon as the disc has been ejected, it can be removed.

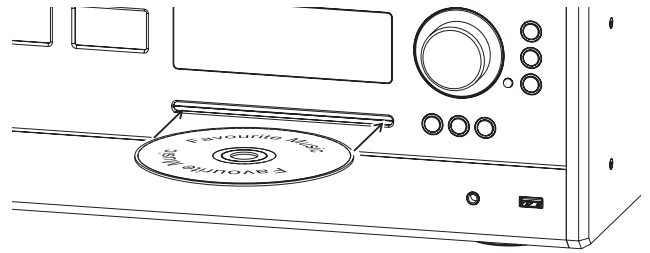

**i** The disc mechanism is designed to play round 12 cm standard discs only. Do not insert 8 cm discs or discs with unusual shapes. These may damage the drive.

## Playback mode

The CD player in the R 2500 R features various playback modes. During playback the current playback mode is shown on the screen.

Big display view



Detailed display view



The playback mode can be set with the remote control only. Long presses on the ↶ button on the SRC2 select the playback mode. Press repeatedly if necessary.

The following modes are available:

|              |  |
|--------------|--|
| No indicator | Normal playback of the whole disc, or normal program playback.                                 |
| ↶            | The tracks of the CD or a playback program are continuously repeated                           |
| ↶1           | The track of the CD or a playback program which has just been played is continuously repeated. |
| ↻            | The tracks of the CD or a playback program are mixed (Shuffle).                                |
| ↶↻           | The tracks of the CD or a playback program are continuously mixed (Shuffle).                   |



# Radio operation

## General information

The R 2500 R features an FM Tuner (VHF radio) with HD Radio™ technology\*, a DAB / DAB+ reception section (digital radio) and also includes the facility to stream Internet radio. The following section describes in detail how to operate the individual radio sources.

HD Radio technology enables radio stations to transmit analogue and digital programmes on the same frequency simultaneously.

The integral DAB+ receiving section is backwards-compatible with DAB, to ensure that you have access to a wide range of stations.



\* HD Radio™ technology only available in US-version.

## FM Radio

Select the source FM Radio with the source selection button *RADIO* on the SRC2 or by turning the *SOURCE* knob on the front panel of the R 2500 R. Confirm your selection with a short press on the **OK** button of the SRC2 or on the *SOURCE* knob of the R 2500 R.

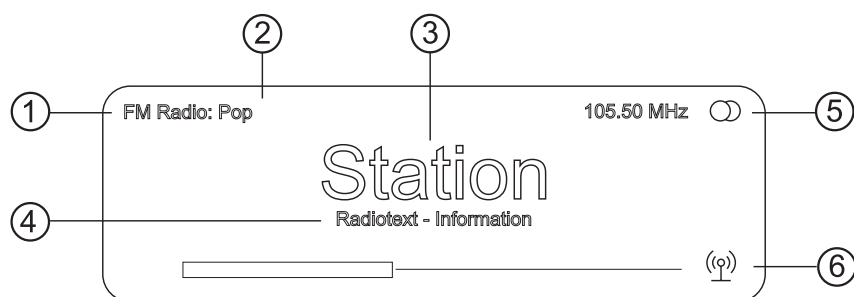
## Display



- ① Displays the selected radio source.
- ② Here the music type or style is displayed, e.g. Pop Music. This information is only displayed if the transmitting station broadcasts it as part of the RDS system. If you are listening to a station which does not support the RDS system, or only supports it in part, these information fields remain empty.
- ③ The frequency and / or the station name is displayed in enlarged form. If a station name is displayed, its frequency is shown in area ⑤.
- ④ These lines display information which is broadcast by the station (e.g. Radiotext).
- ⑤ Display of Stereo  /  Mono
- ⑥ The field strength and therefore the reception quality to be expected from the set transmitting station can be assessed from the field strength.  
FM Radio: when receiving an HD Radio broadcast, here the currently selected programme from the total number of programmes available is displayed too (left side), e.g. programme 2 of total 3 available.

## Manual station search

---

### Operation by remote control

Press and hold one of the **cursor left / right** buttons on the remote control to start the station search in upward or downward direction. The station search stops automatically at the next station found. By repeatedly short presses on the buttons on the remote control, it is possible to select a specific frequency. Once the desired station has been selected, it can be added to the Favourites list by pressing the ☺ button. (see also chapter „Favourite lists“)

---

### Operation at the device

Manual selection of a specific frequency is also possible via the SELECT knob on the device. By pressing the SELECT knob several times, if necessary, you can switch between the functions of the SELECT knob for a short time. The currently selected operating mode is shown at the bottom left of the display (only in the detailed display setting). The following functions can be selected:

| Display indicator | Function                                    |
|-------------------|---|
| Freq              | Manual frequency tuning                     |
| Fav               | Selecting a stored favourite                |
| HD                | HD Radio programme selection (if available) |

**i** The method of searching for an HD Radio station is the same as for an analogue FM station search. As soon as you select a station with a HD Radio programme, playback automatically switches to the digital programme.

## Automatic station search

---

A long press on the menu ⚙ button on the R 2500 R's front panel or on the ⚙ button of the remote control opens the station list menu. The following menu items are available:



- If you wish to create a new station list, select the item “Create new list” and confirm your choice with **OK**.
- The station search begins, and automatically searches for all radio stations which the machine is able to pick up.
- If you wish to update an existing list, select the item “Add new stations”.
- The menu item “Sort stations by ...” allows you to sort the stored list by any of several criteria.

## Mono / Stereo selection

---

By a long press on the I/II button of the remote control, the FM tuner of the R 2500 R can be switched between stereo and mono reception. The reception mode is shown in the display:

## Switching Radio text on and off

---

The Radio text function can be switched on and off by long presses on the ⓘ button on the remote control handset. Repeatedly if necessary.

## DAB Radio

Select the source *DAB Radio* with the source selection button *RADIO* on the SRC2 or by turning the *SOURCE* knob on the front panel of the R 2500 R.  
Confirm your selection with a short press on the **OK** button of the SRC2 or on the *SOURCE* knob of the R 2500 R.

## Display

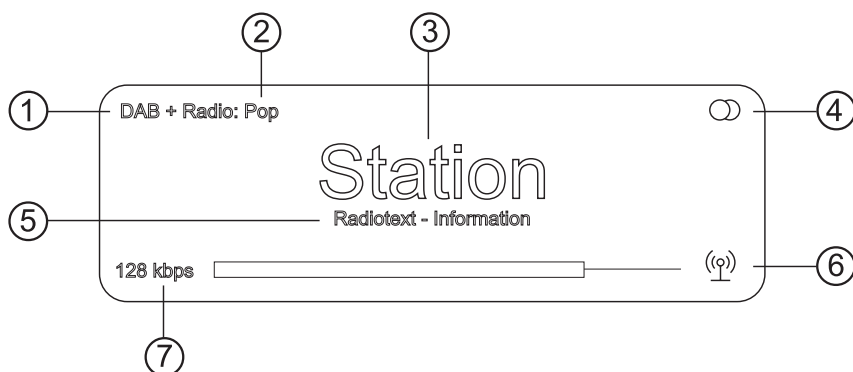

- ① Displays the selected radio source.
- ② Here the music type or style is displayed, e.g. Pop Music.  
This information is only displayed if the transmitting station broadcasts it as part of the RDS system. If you are listening to a station which does not support the RDS system, or only supports it in part, these information fields remain empty.
- ③ Display of the station name
- ④ Display of Stereo  /  Mono
- ⑤ These lines display information which is broadcast by the station (e.g. Radiotext).
- ⑥ The field strength and therefore the reception quality to be expected from the set transmitting station can be assessed from the field strength.
- ⑦ Bit-rate of the broadcasting station when listening to DAB radio.  
\* The higher the bit-rate, the better the station's sound quality.

## Automatic station search

A long press on the menu button on the R 2500 R's front panel or on the button of the remote control opens the station list menu. The following menu items are available:



- If you wish to create a new station list, select the item "Create new list" and confirm your choice with **OK**.
- The station search begins, and automatically searches for all radio stations which the machine is able to pick up.
- If you wish to update an existing list, select the item "Add new stations".
- The menu item "Sort stations by ..." allows you to sort the stored list by any of several criteria.

## Internet Radio

---

Select the source *Internet Radio* with the *RADIO* source selection button on the SRC2 or by turning the *SOURCE* knob on the front panel of the R 2500 R.  
Confirm your selection with a short press on the **OK** button of the SRC2 or on the *SOURCE* knob of the R 2500 R.

## Display

---

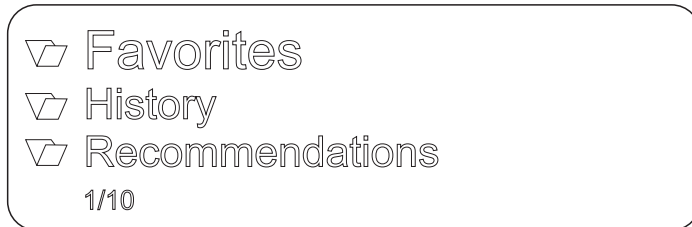

## Search function



---

- Select the entry *Search* in the selection list with the **cursor up / down** buttons and confirm with the **OK** button.
- A pop-up window with the message *Search* appears in the display. While the pop-up window is displayed, enter a letter using the alpha-numeric keys on the remote control.
- To delete a letter, press the **cursor left** button.
- Press the **OK** button to start the search.
- After a short delay, a list with the search results appears.

## Favorites

---

In addition to the presets list provided by the device (see also chapter Preset lists on page 37), the Internet radio source also has a Favorites folder in the root folder of the Internet radio source. This Favorites folder is provided by the Internet radio provider and is independent of the Favorites list in the device.

To save a favorite in this folder, tap the  icon in the T+A Music Navigator app during playback. To delete the favorite from the folder, tap the  icon.

# Presets list

## General information

---

The R 2500 R includes the facility to create Presets lists. The purpose of these lists is to store radio stations and podcasts, so that they can be accessed swiftly.

Each of the sources FM radio, DAB radio, Internetradio and Spotify feature their own Presets list.

Once stored, the Presets can either be selected from the Presets list, or called up directly by entering the program location number. The option of selecting using the location number is particularly useful when you wish to call up Presets when the screen is not in view (e.g. from an adjacent room) or using a house control system.

---

- i** Presets lists for the various music services (TIDAL etc.) are not supported. Instead it is usually possible to add Presets and Playlists on-line via the provider's account. These can then be called up and played via the R 2500 R.

## Calling up the presets list

---

- The first step is to switch to one of the sources listed above.
- Call up the preset list by a brief press on the  button on the remote control.

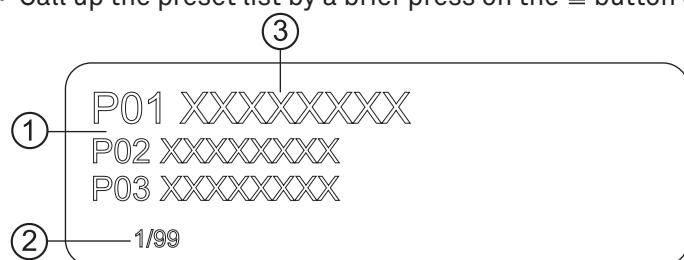

- ① Here the program location number is displayed within the list. Since it is possible to erase individual list items, the numbering may not be continuous.
- ② Position display in the Presets list.
- ③ The selected list entry is displayed in enlarged form.



## Adding a preset

---

If you especially enjoy the piece of music or radio station to which you are currently listening, simply press the  button on the remote control; this action stores the station in the corresponding Presets list.

## Erasing an item from the Presets list

---

Open the Presets list by pressing the  button. Use the **cursor up / down** buttons to select the station in the list which you wish to erase, then hold the  button pressed in; this action removes the item from the Presets list.

## Play Presets



---

- Call up the preset list by a long press on the  button on the remote control
- Select a stored Preset from the Presets list using the **cursor up / down** buttons or by turning the SELECT knob on the R 2500 R. The selected Preset is displayed enlarged.
- A brief press on the OK-button or by pressing the SELECT knob, the Preset is selected for playback.



## Sort Presets

---

The sequence of items in the Presets list you have created can be altered in any way you wish. This is the procedure for changing the order of the list:

- First, call up the preset list by a press on the  button on the remote control.
- Select the Preset that you wish to change the position of with the **cursor up / down** buttons on the remote control or by turning the SELECT knob on the R 2500 R. The selected Preset is displayed enlarged.
- Pressing the  button on the remote control activates the sort function for the selected Preset. The Preset is highlighted.



- Now move the activated Preset to the desired position in the Presets list using the **cursor up / down** buttons on the remote control or by turning the SELECT knob on the R 2500 R.
- Pressing the  button again deactivates the sorting function. The Preset is now stored at the new position.
- A brief press on the  button closes the preset list.

---

 *If you have previously erased a number of Presets, you may well find that some program locations in the Presets list are missing (empty). Nevertheless, the Presets can still be moved to any location in the list!*

# Input operation

## General information

---

The R 2500 R can be used as a high-quality D/A converter for other devices such as computers, streamer, digital radios etc. which are fitted with poor-quality converters or no converter at all. The R 2500 R features two optical, one electrical S/P-DIF digital inputs and two HDMI-inputs on the back panel to allow this usage.

The USB-DAC input on the back panel permits to use the R 2500 R as D/A converter for computers.

## D/A Converter Operation

---

Choose the digital input to which you have already connected the source device which is to be played.

As soon as the source device delivers digital music data, the R 2500 R automatically adjusts itself to the format and sampling rate of the signal, and you will hear the music.

 *During D/A converter operations the R 2500 R integral screen displays the characteristics of the digital input signal.*

## Source selection

---

Choose the desired listening source by pressing the SCL-button on the SRC2 and then choose the desired source from the list with the **cursor up / down** buttons and confirm with the OK button. To select the source on the front panel of the R 2500 R press the SCL button and turn the SELECT-knob to the desired source and confirm with a short press on the knob.

## USB Media

---

The R 2500 R features two USB inputs for memory sticks or hard disks, one in the front panel and one in the backpanel. Select USB 1 or USB 2 for the source you want to listen to.

The memory medium can be formatted with any of the following file systems: FAT16, FAT32, NTFS, ext2, ext3 or ext4.

## Bluetooth

---

### General information

---

The R 2500 R integral Bluetooth interface provides a means of transferring music wirelessly from devices such as smart-phones, tablet PCs, etc. to the R 2500 R.

### Source selection

---

The *Bluetooth* source can be selected using the remote control by pressing the INPUT button and then using the **cursor up / down** buttons.

Alternatively, after pressing the INPUT button on the device, the selection can be made by turning the SOURCE button and then pressing to confirm.

## Setting up audio transfer

---

Before music from a Bluetooth-capable device can be played through the R 2500 R, the external device must first be registered to the R 2500 R. As long as the R 2500 R is switched on and no device is connected, it is always ready to receive. In this state the screen displays the message *not connected*.



To establish a connection, carry out the following steps:

- Start the search for Bluetooth devices on your mobile device.
- If the R 2500 R is found, select it for pairing.

If the connection is successfully established, the device name of the connected device is shown at the bottom right of the display.

## Playback

---

Information on the piece of music currently being played is displayed on the screen of the R 2500 R if this function is supported by the device connected to the unit.

The behaviour and method of operating the connected mobile device are determined by the device itself. Usually, playback can be controlled via the buttons on the remote control (start/stop, pause, skip).

---

 *To control the R 2500 R the mobile device must conform to the Bluetooth AVRCP protocol.*



Qualcomm is a trademark of Qualcomm Incorporated, registered in the United States and other countries, used with permission. aptX is a trademark of Qualcomm Technologies International, Ltd., registered in the United States and other countries, used with permission

## HDMI

---

At the HDMI 1 and HDMI 2 inputs, the R 2500 R accepts digital PCM encoded stereo signals with sampling rates of 32 ... 384 kHz (32 bit) and DSD data with a sampling rate of DSD64 / 128.

If a TV is connected to the HDMI OUT output, the TV sound can be transmitted to the R 2500 R via ARC (Audio Return Channel) if supported by the TV. The ARC mode is activated by a short press on the I/II button.

If necessary, the R 2500 R can be switched to By-Pass mode for the HDMI 1 or 2 inputs by a long press on the I/II button. In this case, the sound is played back by the TV.

 *To use the ARC function, the TV must support it and the R 2500 R must be connected to an ARC compatible input.*

## Digital IN 1 ... IN 3 (S/P-DIF)

---

You can connect devices with electrical co-axial or optical output to the digital inputs of the R 2500 R. At inputs DIGITAL IN 1 to DIGITAL IN 3 the R 2500 R accepts digital stereo signals conforming to the S/P-DIF norm, with sampling rates of 32 to 192 kHz and DSD 64 (DOP).



## USB DAC Playback from a computer

---

At the USB DAC inputs the R 2500 R accepts digital PCM-encoded stereo signals with sampling rates of 44.1 to 768 kHz (32-bit) and DSD data with sampling rates of DSD64, DSD128, DSD256 and DSD512.

---

### Minimum system requirements

Intel Core i5 or higher or a comparable AMD Processor, 4 GB RAM, USB 2.0 Interface, Microsoft Windows 10, 8.1, 8 or 7, Linux with 4.4 Kernel or higher or MAC OS X 10.13.6 or later version

---

### Driver installation for Windows

For playback via USB, from a connected Windows PC, specific driver software is required on the computer. The required drivers and a detailed installation manual are available for download on our homepage at <http://www.ta-hifi.com/support>.

No drivers are required when using a computer with Linux or Mac OS.

---

### System settings

A number of system settings have to be altered if you wish to operate R 2500 R with your computer. These changes must be made regardless of the operating system. The installation instructions provide detailed information on how and where the settings are to be changed.

---

### Playback

- If necessary, first reduce the set volume.
  - Switch on the computer.
  - Select the USB input using the source selection buttons on the device or the remote control.
  - If necessary, select the R 2500 R as the output device in the system settings of the operating system.
  - Open the playback software on the computer.
- 

 *Do not disconnect the USB connection during operation. Do not turn off the R 2500 R during playback. This can lead to malfunctions and crashes. If there is a malfunction during playback, restart the computer.*

---

*The playback of files stored on the computer cannot be controlled by the R 2500 R or SRC2.*

*The playback of DSD files on Apple MAC computers is restricted to a maximum of DSD 256, as Apple only supports playback in DOP format and does not support native streaming.*

---

## Analog IN 1 ... IN 3

---

Universal preamplifier line inputs for connecting any stereo audio devices with balanced XLR output or unbalanced RCA output.

The IN 1-3 input can be switched to a separate volume control in the system configuration menu for operation with surround decoders (Bypass mode).

---

## Hotkeys

---

- ★ 1 The SRC2 features two hotkeys allowing to store two favorite sources.
  - ★ 2 To store a playing source on one of the keys a long press on the key is required.  
A short press on one of the keys opens the stored source.  
A brief press on the OK-button or by pressing the SELECT knob, the hotkey is activated for playback.
- 

 *The hotkey function is not available for Apple Airplay and Tidal Connect*

---

# HDMI connection

## Connection variants

Depending on the usage, various options are available for connecting the R 2500 R via HDMI to source devices such as a BluRay player and a television, surround receiver, beamer or similar devices. Some sample configurations are shown below. The table gives an overview about the functions available for the various configurations (depending on the devices used).

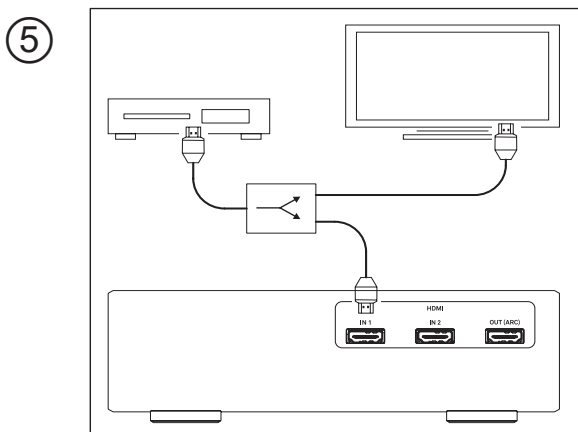
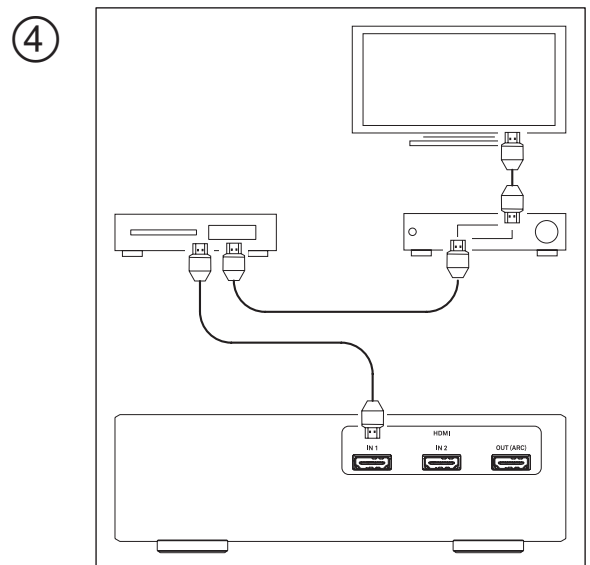
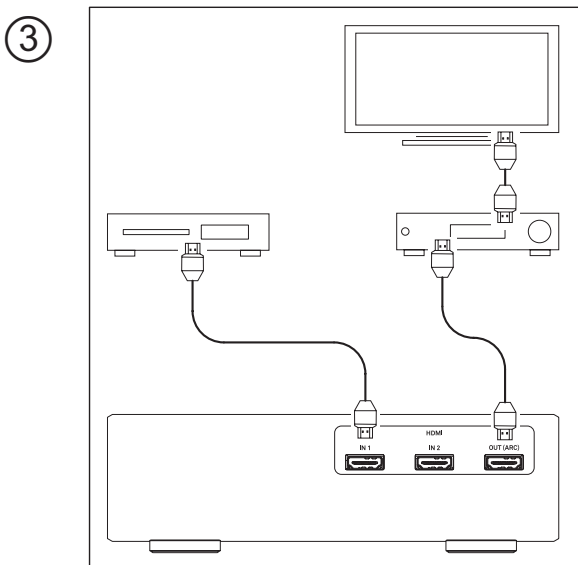
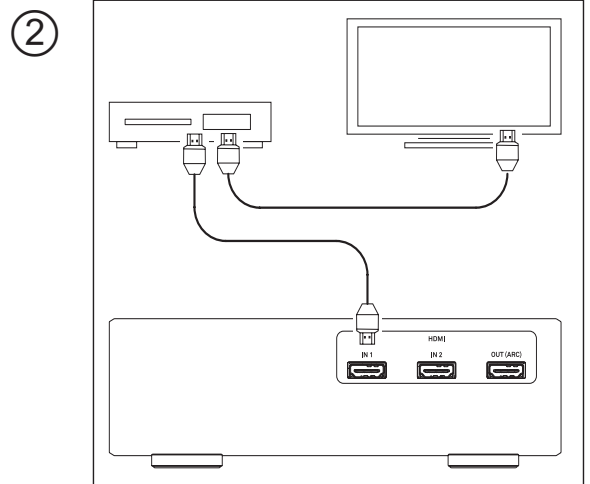
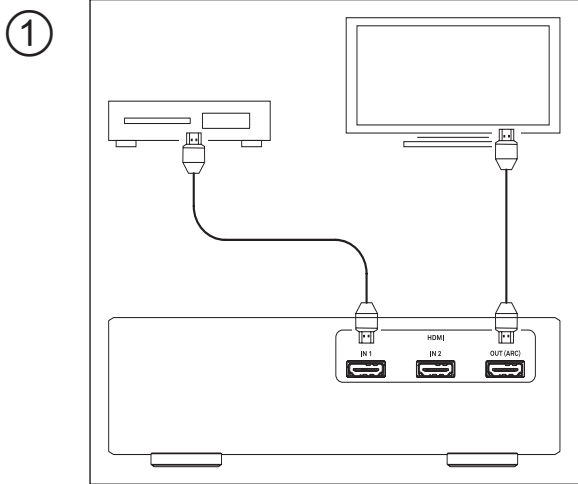

## Compatibility information

---

Due to the large number of different versions of the HDMI standard, a general compatibility between the devices cannot be guaranteed. Not all manufacturers implement all functions in the same way. Please refer to the user manual of the respective device to find out whether the desired function is available.

---

**i** To use the ARC (Audio Return Channel) function, the TV must support it and the R 2500 R must be connected to an ARC compatible input of the TV.

---

### HDMI Bypass

This function allows you to select whether the audio signal at the HDMI connections HDMI 1 and HDMI 2 is to be played back by the R 2500 R, or whether it is passed on for playback by a device connected to the HDMI output.

---

**i** Switch on the HDMI bypass function if the R 2500 R is connected between the source device and the television / surround amplifier, and you wish to play back the sound through the television or surround amplifier.

---

## Playback

---

Since the R 2500 R is designed for pure stereo playback, only 2-channel PCM or DSD64/DSD128 encoded material can be played back via the HDMI inputs of the R 2500 R. For playback via the R 2500 R, the configuration of the HDMI output at the source device may need to be changed. Set the HDMI output to PCM output and activate DSD playback via HDMI if available. Always select the stereo track in the menu of the inserted disc.

If you wish to play back a disc in surround format (e.g. Dolby Digital or DTS) via the television or a surround amplifier, the sound can be passed on from the R 2500 R to that unit (see HDMI Bypass settings).

---

## Display of format and sampling rate

---

| Format             | Playback via R 2500 R | For example   |
|--------------------|-----------------------|---|
| PCM (32...384 kHz) | YES                   | CD, DVD or BluRay with 2-channel stereo sound, e.g. concert recording |
| DSD (DSD 64 / 128) | YES                   | Playing a SACD (stereo track)   |
| Bitstream          | NO                    | Playback of a DVD or BluRay with surround encoded movie or similar.   |
| Multi Ch.          | NO                    |   |

---

## Protection

---

The Protection circuit protects the R 2500 R from damage caused by short-circuit, overheating and overloading. If a problem occurs, the protection circuit switches the output signal off, the loudspeaker output buttons start to flash, and the screen displays one of the following messages:

*Overheat* indicates that the amplifier has become too hot. If this should occur, the machine should be left switched off for a generous period in order to cool down. Ensure that there is an adequate flow of cooling air to and from the machine. It will not be possible to switch the machine on again until it has cooled down to the appropriate temperature.

*Clipping* appears if the volume is set too high, causing distortion at the loudspeaker output. The R 2500 R detects this automatically, and reduces the volume accordingly.

*Short R* means the right-hand loudspeaker output is short-circuited. If this should happen, please check the loudspeaker cables.

*Short L* means left-hand loudspeaker output is short-circuited. If this should happen, please check the loudspeaker cables.

---

**i** If you find it impossible to solve a problem with the help of these notes please disconnect the unit from the mains and ask your authorised T+A specialist dealer for advice.

---

# Firmware update

## General information

---

For updating the firmware of the R 2500 R there is a convenient method which requires an existing Internet connection

The wiring diagram for the machine is shown in the chapter Connection and wiring.

The following section describes the exact method of updating the firmware in detail.

---

 *To avoid malfunctions after updating the R 2500 R, all devices in the system should always be checked for any available updates and installed if they are available.*

## Update procedure

---

- The basic requirement is a functioning network with router and access to a broadband Internet connection; the system must be operating.
- Switch the machine on.
- Call up the System menu by pressing the  button on the front panel.
- Rotate the SELECT knob on the front panel to select the *Device info* menu point, and confirm your selection by pressing the SELECT knob.
- Select the *Update* menu point by rotating the SELECT knob, then press the SELECT knob to confirm your choice.
- The select option *WEB* should now be active (highlighted).
- The firmware update can now be started by pressing the SELECT knob.
- The screen displays the current state of progress of the update.
- Once the update has been completed (duration 10 - 40 minutes) the device automatically switches itself off and restarts.
- When the machine has restarted, the update is complete.
- To ensure that the update was successful, access the *Device Info* menu point mentioned above, and check the new firmware status.

---

 *Instead of starting the update process directly on the device, it is also possible to operate the update process via the SRC2 remote control.*

# Troubleshooting

Many problems have a simple cause and a correspondingly simple solution. The following section describes a few difficulties you may encounter, and the measures you need to take to cure them. If you find it impossible to solve a problem with the help of these notes please disconnect the unit from the mains and ask your authorised T+A specialist dealer for advice.

## Machine does not switch on

---

Cause:

Mains leads not plugged in correctly.

Remedy:

Check connection, push connector in firmly.

## Device responds correctly to operation via the buttons directly on the device, but cannot be operated by remote control

---

Cause:

The battery of the SRC2 remote control is completely discharged.

Remedy:

Insert a new battery as described in the Remote control chapter.

## The RDS station name and/or the Radio Text does not appear in the display.

---

Cause 1:

Reception is poor, interference is severe, or the field strength (signal strength) is low.

Remedy:

Select only those stations which can be received with a strong signal: hiss-free and without interference.

---

Cause 2:

The display view is in the large format setting.

Remedy:

Switch to the detailed display view using the **i** key on the device. If necessary, tap several times to switch on the radio text.

## One or more sources cannot be selected via the source selection buttons on the device and the remote control

---

Cause :

The source in question has been disabled.

Remedy:

Enter the system settings menu and enable the disabled source.

## Transmission interruptions occur when listening to internet radio stations.

---

**Cause:**

The capacity of the internet radio station's server is at its limit.

**Remedy:**

Choose a different station.

## The streaming client cannot connect to a network.

---

**Cause 1 (cable LAN):**

Network cable not properly connected

**Remedy:**

Connect network cable, check connection to router

**Cause 2 (wireless LAN):**

WLAN antenna not connected or placed in a location with bad reception quality

**Remedy:**

Connect WLAN antenna properly and find a location with good reception quality.

Set the transmission power output of your WLAN router to maximum.

Try to establish a network connection first in a location close to the WLAN router. If this succeeded try to connect to WLAN from a more remote location. Experiment with antenna position and try to find a location with better reception quality.

**Cause 3 (wireless LAN):**

WLAN reception quality bad (low field strength). Possibly too much attenuated by walls/ceilings on the transmission path.

**Remedy:**

Optimize location of receiver and transmitter antennas.

**Alternative:**

If transmission problems persist a so called 'Power Line' network might be good alternative to establish a good and stable network connection.

The best, safest and most secure network however will always be a cable LAN network.

**Cause 4:**

Network parameters not properly configured.

**Remedy:**

Configure the network parameters correctly (see chapter 'Network configuration').

**Cause 5 (operation without network connection):**

For proper operation the R 2500 R needs at least one properly connected network device. This can be a LAN or WLAN network or a USB storage device.

**Remedy:**

If the R 2500 R shall be operated without network (LAN / WLAN) please connect at least a USB stick.

## USB Storage device is not recognised

---

**Cause 1:**

The storage device (especially USB hard discs without separate power supply) draws more electrical current from the USB interface than is permitted by the USB standard.

**Remedy:**

Only use USB storage devices that conform to the USB standard or use storage devices with own power supplies.

**Cause 2:**

The storage device is not formatted with an appropriate file system.

**Remedy:**

The R 2500 R accepts storage devices with FAT16 or FAT32, NTFS, Ext2, Ext3, Ext4 file systems.

# Notes on energy saving

## General information

---

The R 2500 R satisfies the requirements of the latest directives concerning energy-saving measures (EuP directive). The modern design of the mains power supply makes an important contribution to this.

The internal micro-processor constantly ensures that sub-assemblies which are not currently required are automatically switched off. The micro-processor itself operates in stand-by mode at a relatively low clock speed, and only responds to the remote control receiver.

In stand-by mode the current drain of the R 2500 R is less than 0.5 Watt.

If you intend not to use the device for a long period, it should be disconnected from the mains socket, i.e. the mains plug should be withdrawn from the wall socket.

## Automatic power down function

---

The device features an automatic power-down function. If the R 2500 R detects no operation or no music signal for a period longer than 90 minutes, it automatically switches to stand-by mode

---

 *In countries outside the EU, in which the EuP directive has no validity, the automatic power-down feature can be disabled if necessary. See chapter „System settings“.*

# Legal Information

## General information

---

This product contains software in form of object code that is partially based on free software under different licenses. Details of the licenses used can be viewed on the device website using an Internet browser.

## Show licenses

---

For details regarding the used licenses, please visit our website by entering the following link:

<https://www.ta-hifi.de/support/license-information-g3/>

Furthermore, the address can be called up at any time as follows:

- Call up the system configuration menu by pressing the button on the R 2500 R.
- Then navigate to the menu item Device Info. Open it by pressing the SELECT button and navigate to the menu item Legal information and open it with by pressing the SELECT button again.
- The above Internet address is displayed in the pop-up window that now opens.

# Specifications

| <b>Pre-amplifier</b>                       |   |
|--|---|
| Frequency response +0 /-3dB                | 0,5 Hz - 300 kHz  |
| Signal / noise ratio                       | 105 / 109 dB  |
| THD   Intermodulation   Channel separation | < 0,001 %   < 0,001 %   > 90 dB   |
| Nominal input sensitivity                  |   |
| High level input unbalanced (RCA)          | 250 mV <sub>eff</sub> ... 4 V <sub>eff</sub> / 20 kOhm (IN 2 and IN 3)  |
| High level input balanced (XLR)            | 500 mV <sub>eff</sub> ... 8 V <sub>eff</sub> / 5 kOhm   |
| Analogue pre-amplifier output (RCA)        | nom 1 V <sub>eff</sub> , max 9,5 V <sub>eff</sub> / 47 Ohm  |
| <b>Power amplifier</b>                     |   |
| Output power (RMS) per channel             | 250 watts @ 4 ohms  |
|  | 140 watts @ 8 ohms  |
| Frequency response +0 /-3dB                | 0,5 Hz - 150 kHz  |
| Slew rate                                  | 60 V / $\mu$ S  |
| Damping factor                             | > 65  |
| <b>Headphone output</b>                    |   |
|  | 4,4 mm Pentaconn (6 Ohms)   |
| <b>Connections</b>                         |   |
| Digital inputs                             | 3 x S/P-DIF: 1 x Standard Coax, 2 x optical TOS-Link (32...192 kHz / 16-24 Bit), DSD64 (DOP)<br><br>1 x USB DAC: Device-Mode up to 768 kSps (PCM), DOP256 and DSD 512*, supports asynchronous data transfer. *DSD 512 only with Windows PC with appropriate driver or a Linux PC with kernel version 4.4 or higher.<br><br>2 x HDMI IN, 1 x HDMI OUT with ARC |
| <b>D/A-Converter</b>                       |   |
|  | PCM: Double-Differential-Quadruple-Converter with four 32-Bit Sigma-Delta D/AConverters per channel. 705,6 / 768 kSps conversion rate<br>DSD: T+A-True-1Bit DSD D/A-Converter, up to DSD 512 (22,4 / 24,5 MHz), native bitstream  |
| Upsampling                                 | T+A-Signalprocessor – synchronous upsampling with 4 selectable oversampling algorithms. FIR short, FIR long, Bezier/IIR, Bezier   |
| Analogue output filter                     | Phase-linear Bessel filter 3rd order, switchable with 60 or 120 kHz cut off frequency   |



|                    |               |                |                         |
|--------------------|---------------|----------------|-------------------------|
| Frequency response | PCM 44.1 kSps | 2 Hz - 20 kHz  |                         |
|                    | PCM 48 kSps   | 2 Hz - 22 kHz  | DSD 64: 2 Hz - 44 kHz   |
|                    | PCM 96 kSps   | 2 Hz - 40 kHz  | DSD 128: 2 Hz - 60 kHz  |
|                    | PCM 192 kSps  | 2 Hz - 80 kHz  | DSD 256: 2 Hz - 80 kHz  |
|                    | PCM 384 kSps  | 2 Hz - 100 kHz | DSD 512: 2 Hz - 100 kHz |
|                    | PCM 768 kSps  | 2 Hz - 120 kHz |                         |

### CD-Player

|                                      |                             |
|--------------------------------------|-----------------------------|
| Formats                              | CD/DA, CD-R, CD-RW, CD-text |
| Frequency response and dynamic range | 2 Hz – 20 kHz / 100 dB      |

### Streaming Client

|                              |   |
|------------------------------|---|
| Formats                      | MP3, AAC, OGG-Vorbis, FLAC, WAV, AIFF, ALAC, DFF, DSF<br><br>PCM 32 ... 384 kHz, 16/24 Bit; MP3 bis 320 kBit<br>DSD64; DSD128; DSD256   |
| Supported media servers      | UPnP 1.1, UPnP AV and DLNA compatible Server, Microsoft Windows Media Connect Server (WMDRM10, DLNA compatible servers)   |
| Supported streaming services | airable radio and podcasts, Tidal, Qobuz, Deezer, Amazon Music HD, highresaudio, Tidal connect, Spotify connect, Apple Airplay2, Plays with Audirvana, Roon   |
| Features                     | Auto Network Config., Internet Radio Station database (automatic updates)   |
| Interfaces                   | LAN:<br>Fast Ethernet 10/100 Base-T,<br><br>WLAN:<br>IEEE 802.11a/b/g/n/ac/ax 2x2 MIMO<br>2.412 – 2.472 GHz (2.4GHz ISM Band, 13 Channels)<br>Channel 1 – Channel 13<br>North America FCC, Japan MIC, Europe ETSI<br>20MHz bandwidth<br>5.180-5.825 GHz (5GHz UNII-1/2/3 Band, 24 Channels)<br>North America (IC and FCC):<br>5.180-5.600 GHz, 5.650-5.825 GHz<br>Europe, Japan (ETSI and MIC):<br>5.180-5.700 GHz<br><br>• max gain in 2.4GHz band: 3.2dBi<br>• max gain in 5 GHz band: 4.25dBi<br>up to 17dBm (at antenna terminal).<br><br>2x USB 2.0 Mastermode |

### Tuner (FM)

|                           |   |
|---------------------------|---|
| Frequency range           | FM Radio 87,5 – 108 MHz (Europa / US); 76 – 90 MHz (Japanese version) |
| Sensitivity               | Mono (26dB S/N) 0,9 µV, Stereo (46 dB S/N) 40 µV                      |
| Overload margin           | 103 dB µV   |
| Stereo channel separation | 50dB  |
| RDS Functions             | Stationname, Radio text   |

| <b>Tuner (DAB)</b>         |  |
|----------------------------|--|
| Reception standard         | DAB, DAB+  |
| Frequency band             | 168 – 240 MHz (Band III)   |
| Overload margin            | 103 dB $\mu$ V   |
| Sensitivity (BER = 10 – 4) | 2,5 $\mu$ V  |
| <b>Bluetooth</b>           |  |
| Supported audio formats    | A2DP (Audio), AVRCP 1.4 (Control) / aptX <sup>®</sup> HD, SBC, AAC         |
| Frequency band             | 2,4 GHz: 2042Mhz ... 2480Mhz<br>Max. transmission power <10 dBm (EIRP)     |
| RC protocol                | AVRCP  |
| <b>Mains</b>               |  |
| Mains voltage              | 220-240 V, 50-60 Hz / 100-130 V, 50-60 Hz (see back panel of the R 2500 R) |
| Normal operation (max.)    | 800 Watts  |
| Standby (ECO)              | < 0,5 W.   |
| Dimensions (H x W x D)     | 16,5 cm x 46 cm x 40,5 cm / 6,5 x 18,1 x 16 inch                           |
| Weight                     | 14 kg / 30,8 lbs   |
| Accessories                | Power cord, remote control SRC 2, 2x WLAN antenna, FM antenna              |
| Finishes                   | Silver anodised aluminium (43), black anodised aluminium (42), brushed     |

We reserve the right to alter specifications.





T+A elektroakustik GmbH & Co. KG  
Planckstraße 9 – 11  
32052 Herford | Germany

T +49 5221 76760  
F +49 5221 767676

[info@ta-hifi.com](mailto:info@ta-hifi.com)  
[www.ta-hifi.com](http://www.ta-hifi.com)